



# HYPERLINE FX

PTFE Lined Smoothbore Flexible Hose



TEMPERATURE RESISTANT

CHEMICAL RESISTANT

VERY FLEXIBLE

SMOOTHBORE

# CONTENTS

PTFE - The Optimum Choice For Hyperline Hose Linings	<b>Page 3</b>
Hyperline FX Hose Description	<b>Page 4</b>
Hyperline FX Hose Grades	<b>Page 5</b>
Hyperline FX Hose Specifications and Properties	<b>Page 6</b>
Hyperline FX EN 16643 Hose Assembly Electrical Property Grades	<b>Page 7</b>
Hyperline FX Hose Cover Options and Applications	<b>Page 8</b>
Hyperline FX Hose Assembly Supply Options	<b>Page 9</b>
Hyperline FX Hose: Auto-Cut Hose Lengths	<b>Page 10</b>
Hyperline FX Hose : Special Usage Conditions	<b>Page 11</b>
Hyperline FX Hose - Quality Assurance Certificates and Approvals	<b>Page 12</b>
Correct Hose Configuration	<b>Pages 13 - 15</b>
Conditions of Sale	<b>Pages 16 - 17</b>

# PTFE - THE OPTIMUM CHOICE FOR HOSE LININGS

Section from a PTFE Molecule, 16 Angstrom Units long

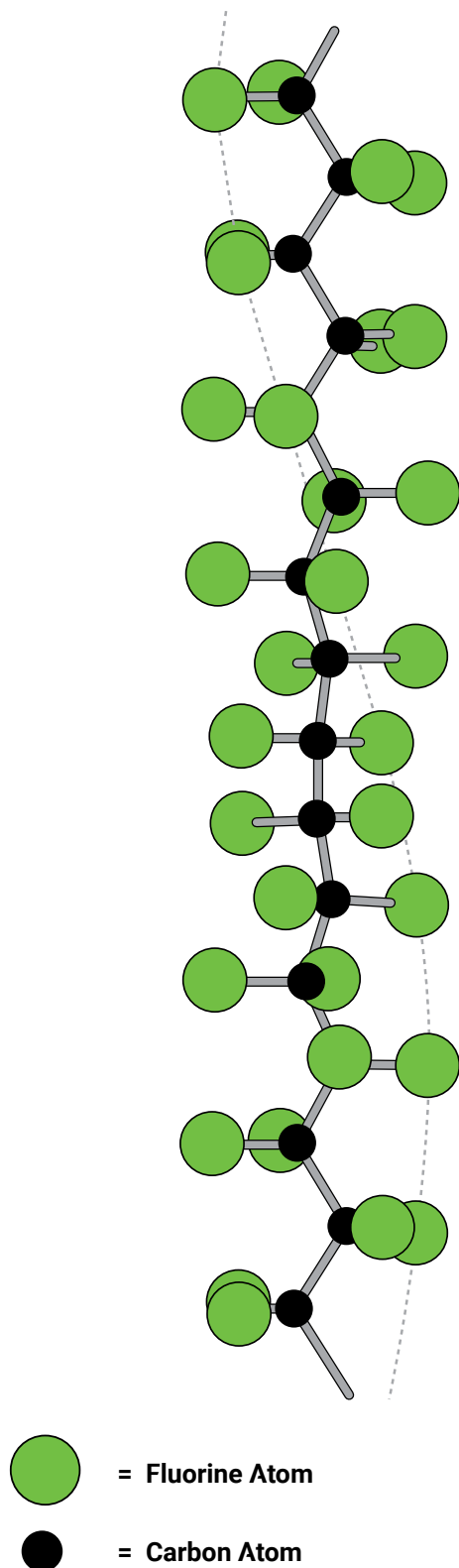

PTFE, or Polytetrafluoroethylene, comprises of long-chain molecules of carbon atoms, each linked to two fluorine atoms.

The fluorine atoms provide a helical spiral which surrounds the carbon chain and protects it.

It is this structure which creates the unique properties for which PTFE is well-known.

- **Excellent Chemical Resistance**

PTFE is renowned as the most chemically resistant material known. Only a very few, very unusual substances and conditions can affect it, like Fluorine gas at high temperature and pressure and liquid, boiling sodium metal.

PTFE lined hoses can therefore be used for a wider variety of chemicals than any other hose type, making it the ideal choice for very corrosive chemical applications and multi-product applications.

- **Non-Stick Surface**

The use of PTFE as a surface for cookware products has demonstrated to the world how easily cleanable PTFE surfaces are.

This means that PTFE lined hoses can be purged 100% clean more quickly, easily and reliably than any other type of hose.

- **Excellent Temperature Range**

The cookware application also demonstrates another of PTFE's many attributes - temperature resistance. PTFE itself can be used as a hose liner at temperatures from -150°C up to +260°C, dependent upon the hose design and the application conditions.

This is the widest temperature range of any rubber or plastic hose lining material.

- **Hose Design**

The only issue with PTFE as a hose lining material is the best way it can be integrated in to the hose design. This is where Aflex Hose have a proven record of success over the last 40 years.

# HYPERLINE FX HOSE DESCRIPTION

There is a fundamental problem with larger sizes of standard, smooth bore PTFE hose products - as the hose size increases above 1/4", so smooth bore PTFE lined hose become significantly less flexible, and more easily kinked.

One solution is to use a conventional convoluted PTFE lined hose, but the internal convolutions make the hose difficult to assemble, and reduces fluid flow rates due to turbulent flow.

Hyperline FX is a new and revolutionary solution to all these problems, providing a unique and patented hose liner design which is flexible in the larger bore sizes, yet which retains a smooth bore.

The advantage of a smooth bore as compared with a convoluted bore is that it is easy clean, and does not create "turbulent flow", which drastically reduces fluid flow rates.

## HYPERLINE FX, SS HOSE ASSEMBLY WITH A HYDRAULIC FIXED MALE END FITTING CRIMPED ON TO THE HOSE

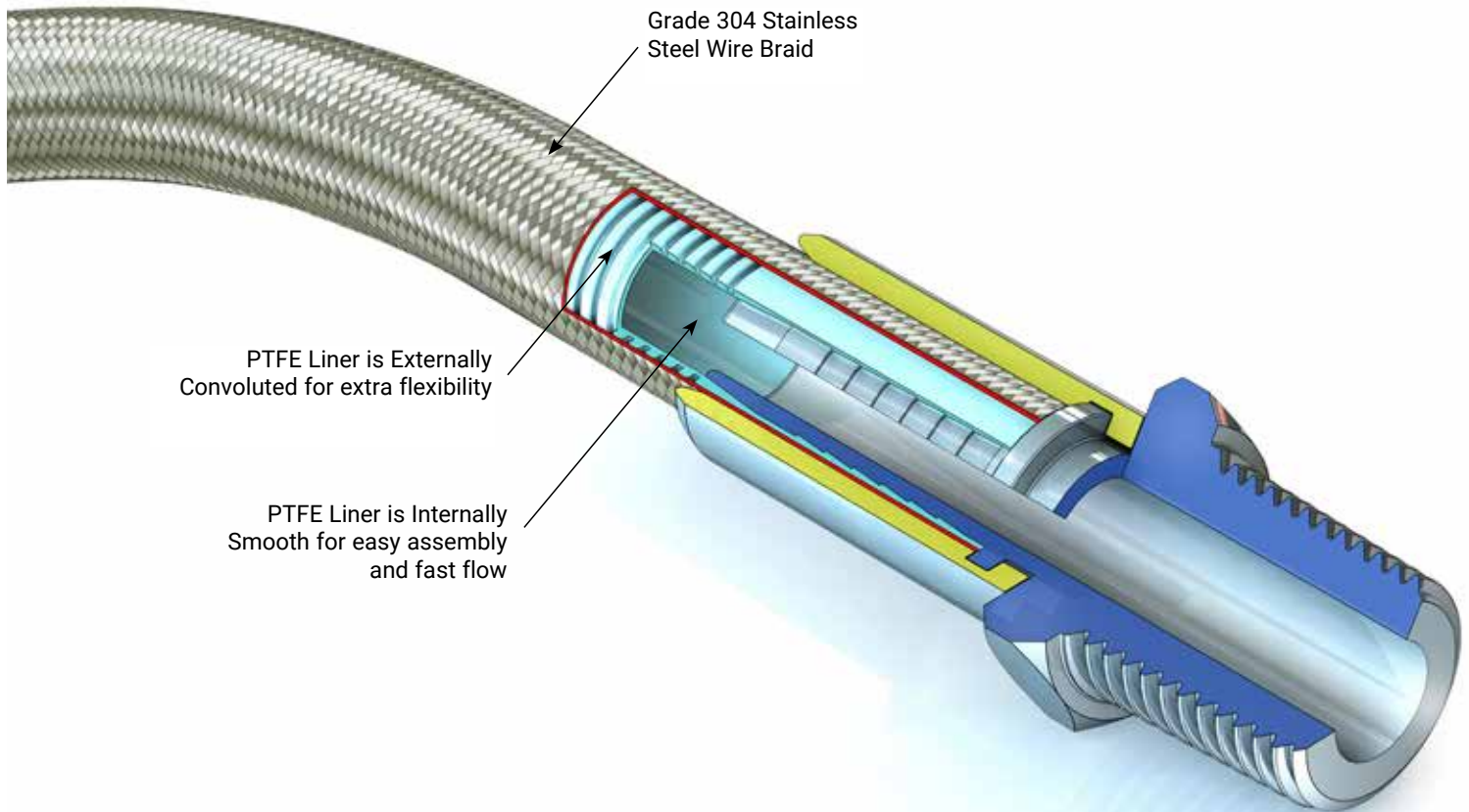

### STANDARD GRADES AVAILABLE

- Hyperline FX, TO** - Natural PTFE Tube Only, No Braid.
- Hyperline FX, AS, TO** - Antistatic Black PTFE Tube Only, No Braid.
- Hyperline FX, SS** - Natural PTFE Tube external AISI 304 Stainless Steel Wire Braid.
- Hyperline FX, AS, SS** - Antistatic Black PTFE Tube, external AISI 304 Stainless Steel Wire Braid.
- Hyperline FX, AM** - Natural PTFE Tube, Black Aramid Fibre Braid.
- Hyperline FX, AS, AM** - Antistatic Black PTFE Tube, Black Aramid Fibre Braid.

# HYPERLINE FX HOSE GRADES

## Natural PTFE Tube Lining

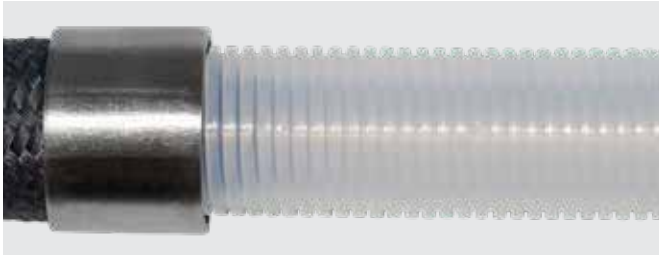

Hyperline FX Natural PTFE Tube is for use in all applications where fluids or gases are being conveyed which do not generate a risk of static charge development (see "AS").

### Tube Only (no braid)



TO grade hose (available in both GP and AS) is a lightweight hose, used in applications where working pressures are low and where there is no need for the physical protection offered by an external braid.

### Stainless Steel Wire Braid (SS Grades)



The braid supports the PTFE liner tube against internal pressure and protects against mechanical abuse. Often used in applications involving high temperatures and working pressures. High tensile 304 stainless steel wire is used to give maximum pressure resistance and external protection to the hose.

### Aramid Fibre Braid (AM Grades)



The aramid fibre is "Tecnora", a higher specification fibre than Kevlar, with excellent temperature, tensile and abrasion resistant properties. For applications requiring minimum weight for maximum pressure reinforcement.

## Antistatic PTFE Linings (AS Grade)



When electrically resistive fluids like solvents and fuels, or multiphase mixtures are passed through natural PTFE hose at high flow rates, a static charge build up occurs on the inner wall of the PTFE liner. This can discharge to the nearest conductor (e.g. SS braid) that creates a pin-hole in the PTFE liner resulting in a leak-path.

Antistatic PTFE includes a small quantity of a special high purity carbon black, which ensures safe static charge dissipation in accordance with International Standards.

### Antistatic Hose Assemblies

When "AS" (Antistatic) grade hose is specified the hose or hose assembly supplied will be tested in accordance with EN ISO 8031 to meet the Antistatic requirements of EN 16643. This requires, for an antistatic liner or antistatic cover, that the resistance between an appropriately placed foam electrode and a metallic end fitting will be between  $10^3$  to  $10^8$  ohms per assembly. For hose assemblies which meet these requirements an appropriate Grade "Ω" marking is applied in accordance with EN 16643 if requested.

**Note:** When in service, at least one end fitting must be connected to earth, to permit dissipation of the static charge from the end fitting.

### EC - ELECTRICAL CONTINUITY

(Also known as 'Electrically Bonded' & 'M' grade)

All Hyperline FX hose assemblies are electrically continuous, except AM (Aramid Fibre) and TO (Tube Only) grade hose assemblies. Electrical Continuity requires that the hose assembly supplied is electrically continuous, or conductive, between metal end fittings at each end of the hose (whether GP or AS grade).

The requirements for this are specified in the German Document BRG 132 and EN 16643, when tested in accordance with EN ISO 8031, which requires that the resistance between end fittings shall be <100 Ohms per assembly. For hose assemblies that meet this requirement a Grade "M" marking is applied in accordance with EN 16643.

# HYPERLINE FX HOSE: SPECIFICATIONS AND PROPERTIES

## SPECIFICATIONS FOR HYPERLINE FX HOSE GRADES

Specifications listed below are for non-AS Grades. For AS Grades the specifications are all the same, except that "AS" is added to the Grade Reference, and the Part Number reads "-110-" in place of "-100-".

Nominal Hose Size		*Actual Hose Bore Size		Hose Grade	Outside Diameter of Tube or Braid		Minimum Bend Radius		Maximum Working Pressure (MWP)		Weight per Unit Length		Hose Part Number
in	mm	mm	in	**	in	mm	in	mm	Bar	Psi	Kg/mtr	Lbs/Ft	
1/4	6.0	6.8	0.270	TO	0.354	9.0	1 1/2	38	4	60	.041	.027	92-100-04
				SS	0.378	9.6	3/4	19	88	1280	.092	.062	92-100-04-01-02
				AM	0.378	9.6	1 1/2	38	62	900	.056	.038	92-100-04-01-55-01
5/16	8.0	7.9	0.312	TO	0.394	10.0	1 1/2	38	4	60	.056	.037	92-100-05
				SS	0.420	10.6	3/4	19	84	1220	.126	.084	92-100-05-01-02
				AM	0.445	11.3	1 1/2	38	59	850	.075	.050	92-100-05-01-55-01
3/8	10.0	10.0	0.394	TO	0.492	12.5	2	50	4	60	.070	.047	92-100-06
				SS	0.534	13.5	1	25	80	1160	.160	.107	92-100-06-01-02
				AM	0.534	13.5	2	50	56	810	.100	.067	92-100-06-01-55-01
1/2	15.0	13.6	0.536	TO	0.640	16.2	3	76	4	58	.110	.074	92-100-08
				SS	0.690	17.5	1 1/2	38	60	870	.225	.151	92-100-08-01-02
				AM	0.690	17.5	3	76	42	600	.140	.094	92-100-08-01-55-01
5/8	16.0	16.7	0.658	TO	0.787	20.0	4	100	3	44	.161	.108	92-100-10
				SS	0.831	21.1	2	50	50	730	.336	.226	92-100-10-01-02
				AM	0.831	21.1	4	100	35	510	.204	.137	92-100-10-01-55-01
3/4	20.0	19.8	0.780	TO	0.913	23.2	5	126	3	44	.179	.120	92-100-12
				SS	0.953	24.2	2 1/2	63	42	610	.383	.257	92-100-12-01-02
				AM	0.953	24.2	5	126	29	430	.236	.158	92-100-12-01-55-01
1	25.0	26.0	1.023	TO	1.193	30.3	6	150	2	29	.268	.180	92-100-16
				SS	1.250	31.7	3	75	40	580	.540	.362	92-100-16-01-02
				AM	1.250	31.7	6	150	28	400	.354	.237	92-100-16-01-55-01

\***Hydraulic Bore Size** - The actual bore sizes of Hyperline FX hose are slightly larger than the nominal size, to allow the insertion and assembly of standard Hydraulic Fittings, using ferrules supplied by Aflex Hose (see page 9).

## PROPERTIES

### Temperatures and Pressures

**Hyperline FX, SS Grades** - The MWP listed above should be reduced by 1% for each 1°C above 160°C (1% for each 1.8°F above 320°F) up to a maximum of 260°C (500°F).

**Hyperline FX, AM Grades** - The MWP listed above should be reduced by 1% for each 1°C above 130°C (1% for each 1.8°F above 266°F) up to a maximum of 180°C (356°F).

**Maximum Working Pressures (MWP)** listed are calculated on the basis of a 3:1 safety factor relative to the burst pressure, so Burst Pressure = 3 x MWP. If MWP is required based on a 4:1 safety factor (e.g. EN 16643 requirement), multiply the listed value by 0.75.

### Vacuum Resistance

Hyperline FX, SS Grades are vacuum resistant to -0.9bar up to 150°C (300°F).

### LOOSE HOSE LENGTHS

Loose hose is supplied in random lengths up to a maximum of 18 metres (60 feet) long.

### ASSEMBLED HOSE LENGTHS

Hyperline FX hose assemblies are made up to the specific lengths required. The hose length is taken as the length from the sealing face at one end of the hose to the same at the other end. The length tolerance is normally +2% / -0%. Closer tolerances are available to special order.

### Excellent Flow Rates

Compared with conventional convoluted hose designs, Hyperline FX has excellent flow rates due to the smooth bore, which prevents the turbulent fluid flow which occurs in convoluted hose products.

### Reduced Diffusion Rates

Hyperline FX is much more resistant to diffusion of liquids or gases than other PTFE hose products, due to its highly compressed, non-porous PTFE matrix. Hyperline FX has been successfully tested to SAE J1737 for resistance to automotive fuel diffusion.

### Non-Stick Internal Surface

Hyperline FX hose has a smooth bore, non-stick liner which is effectively "self-cleaning", and which resists material build-up inside the hose which may cause bore constriction.

# HYPERLINE FX

## EN 16643 HOSE ASSEMBLY ELECTRICAL PROPERTY GRADES

The hose assembly electrical property grades and electrical resistance limits are defined within EN 16643 and tested in accordance with BS EN ISO 8031. Aflex Hose electrically conductive (**EC**) assemblies are defined in EN 16643 as *electrically bonded* and given the symbol **M**. M-grade assemblies exhibit a maximum electrical resistance of 100Ω between end fittings. Aflex Hose anti-static (**AS**) PTFE liners and rubber covers are termed *static dissipative* within EN 16643 and given the symbol **Ω** followed by letters that specify either the liner, cover or both; **L**=liner, **C**=cover, **CL**= cover & liner. Ω-grade covers or liners exhibit an electrical resistance of 10<sup>3</sup>-10<sup>8</sup> Ω.

The table below identifies each EN 16643 electrical grade for a hose assembly along with a brief description and example assembly configuration.

EN16643 Electrical Grade For Hose Assembly	EN16643 Description	Example Hose Assembly
Grade M	Electrically bonded without static-dissipative lining or cover	HFX GP SS Sarlink Ends Fixed male
M/Ω-L	Electrically bonded and static-dissipative lining	HFX AS SS Sarlink Ends Fixed male
M/Ω-C	Electrically bonded and static-dissipative cover	HFX GP SS EPDM (AS) Ends Fixed male
M/Ω-CL	Electrically bonded and static-dissipative cover and lining	HFX AS SS EPDM (AS) Ends Fixed male
I	Electrically insulated (no electrical bonding AND no static-dissipative layers)	HFX GP AM Ends Fixed male
Ω-L	Static dissipative lining without electrical bonding	HFX AS AM Ends Fixed male
Ω-C	Static dissipative cover without electrical bonding	HFX GP AM EPDM(AS) Ends Fixed male
Ω-CL	Static dissipative cover and lining without electrical bonding	HFX AS AM EPDM(AS) Ends Fixed male

# HYPERLINE FX HOSE COVER OPTIONS AND APPLICATIONS

## ALTERNATIVE DESIGN OPTIONS - HOSE COVERS

For certain applications, it is an advantage to have a flexible plastic or rubber outer cover extruded on to the hose. The cover provides protection for the braid, as well as being easy to clean, and can be printed with a continuous text line.

Covered hose is, however, only available to special order, so price and availability are very dependent upon quantities required.

Options are:

### Flexible PVC :

from  $-10^{\circ}\text{C}$  ( $+14^{\circ}\text{F}$ ) to  $+60^{\circ}\text{C}$  ( $+140^{\circ}\text{F}$ ) max. In transparent or a wide variety of solid or translucent colours.

### Nylon 11 :

from  $-40^{\circ}\text{C}$  ( $-40^{\circ}\text{F}$ ) to  $+120^{\circ}\text{C}$  ( $+248^{\circ}\text{F}$ ) max. In natural, semi-transparent or black.

### Sarlink, Hytrell, Polyurethane :

from  $-40^{\circ}\text{C}$  ( $-40^{\circ}\text{F}$ ) to  $+125^{\circ}\text{C}$  ( $+257^{\circ}\text{F}$ ) max. Others may also be available.

### EPDM Rubber :

from  $-40^{\circ}\text{C}$  ( $-40^{\circ}\text{F}$ ) to  $+140^{\circ}\text{C}$  ( $284^{\circ}\text{F}$ ) max. In Blue or (antistatic) Black.

### Silicone Rubber :

from  $-73^{\circ}\text{C}$  ( $-100^{\circ}\text{F}$ ) to  $+204^{\circ}\text{C}$  ( $400^{\circ}\text{F}$ ) max. Peroxide cured, in natural (semi-transparent) or white.

Other rubbers may also be available.

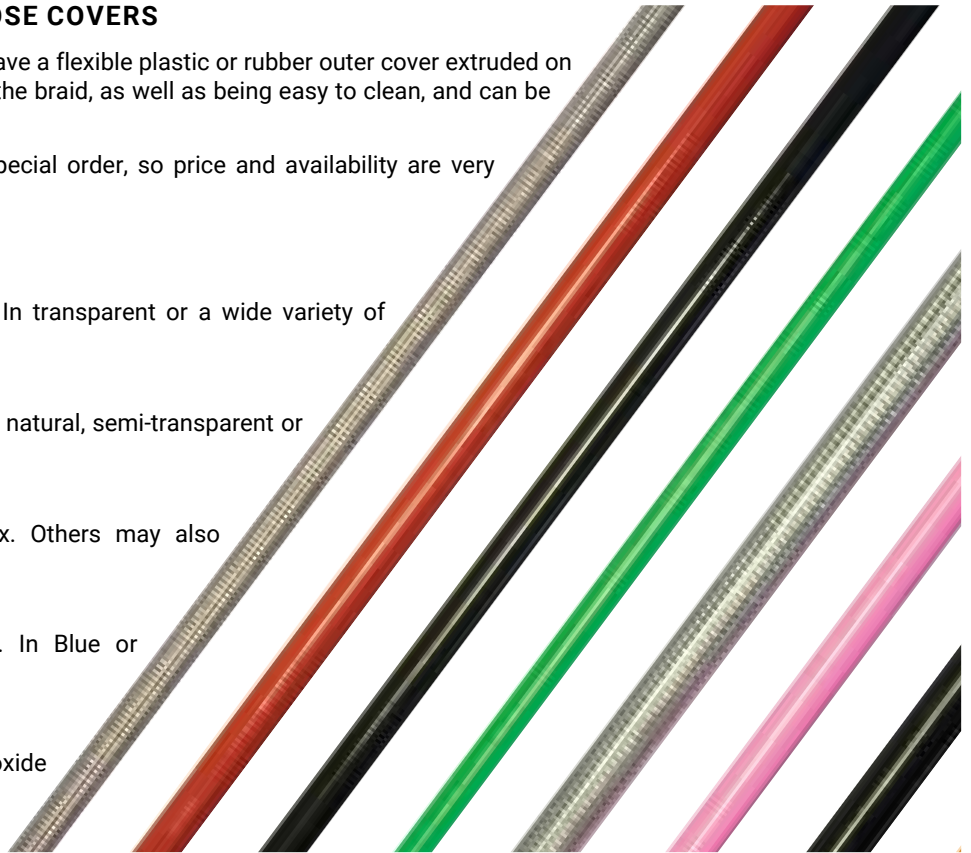

## APPLICATIONS FOR HYPERLINE HOSE

### Automotive and Motorsport :

Replacing conventional PTFE hoses in ESP systems, fuel systems, braking systems and oil lines.

### Refrigeration :

Refrigerant feed lines to freezer plates, where the high resistance to permeation, together with the flexibility and chemical resistance, are primary advantages.

### Steam and Gas Lines :

Where the smooth bore ensures non-turbulent gas flow, leading to noise free operation at higher flow rates, and longer service life.

### Industrial applications :

In general where the ease of assembly to end fittings together with the higher flow rates, chemical and temperature resistance and resistance to permeation make Hyperline FX the optimum choice.





# HYPERLINE FX HOSE ASSEMBLY SUPPLY OPTIONS

## SUPPLY OPTIONS

Hyperline FX hose can either be supplied as made up and crimped hose assemblies, or as loose hose for customers to assemble themselves, using ferrules supplied by Aflex Hose, and standard hydraulic end fittings, which can also be supplied by Aflex Hose if required.

## EASIER ASSEMBLY

Hyperline FX is very flexible, and is designed to replace conventional flexible tape wrapped convoluted or autoconvoluted PTFE hoses in application where **faster, cleaner fluid flow or ease of assembly** is paramount. SS or MS ferrules and crimp diameters can be supplied to suit any conventional hydraulic hose tail end fittings.

Problems associated with assembling fittings to convoluted hoses, such as leakages, the need for special or sleeved spigots, the need to de-convolute etc. disappear - Hyperline FX is literally as easy to assemble as any smooth bore hose.

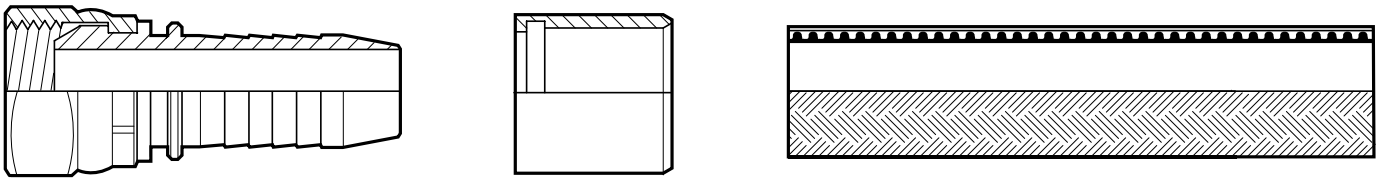

## ASSEMBLY INSTRUCTIONS

1. Cut the hose to the desired length using a cut off machine with a high tensile steel blade, allowing for the length of the end fittings.
2. Push the ferrule onto the hose (chamfered end first) and insert the fitting and push into the hose until it meets the collar on the fitting. Align the ferrule over the collar.
3. Place the assembly into the swaging machine and swage down the ferrule to the recommended swage dimension as given in Aflex Document AS-42. Check using a vernier or micrometer.

To find AS-42 and the current swage diameters, consult the Aflex Hose I-Bay system. To obtain the I-Bay address, please contact Aflex Hose.

## FERRULES TO SUIT

Hose Size	Ferrule Part Number*
1/4	01-170-04-04-(*03 or 04)
3/8	01-170-06-06-(*03 or 04)
1/2	01-170-08-08-(*03 or 04)
5/8	01-170-10-10-(*03 or 04)
3/4	01-170-12-12-(*03 or 04)
1	01-170-16-16-(*03 or 04)

\*Note: Ferrule Part Numbers end in -03 for Stainless Steel (Grade 303 or 304), and -04 for Mild Steel (Zinc Plated).

## PRESSURE TESTING INSTRUCTIONS

All self-assembled hose assemblies must be pressure tested to 1.5 x MWP before end use.

# HYPERLINE FX HOSE AUTO-CUT HOSE LENGTHS

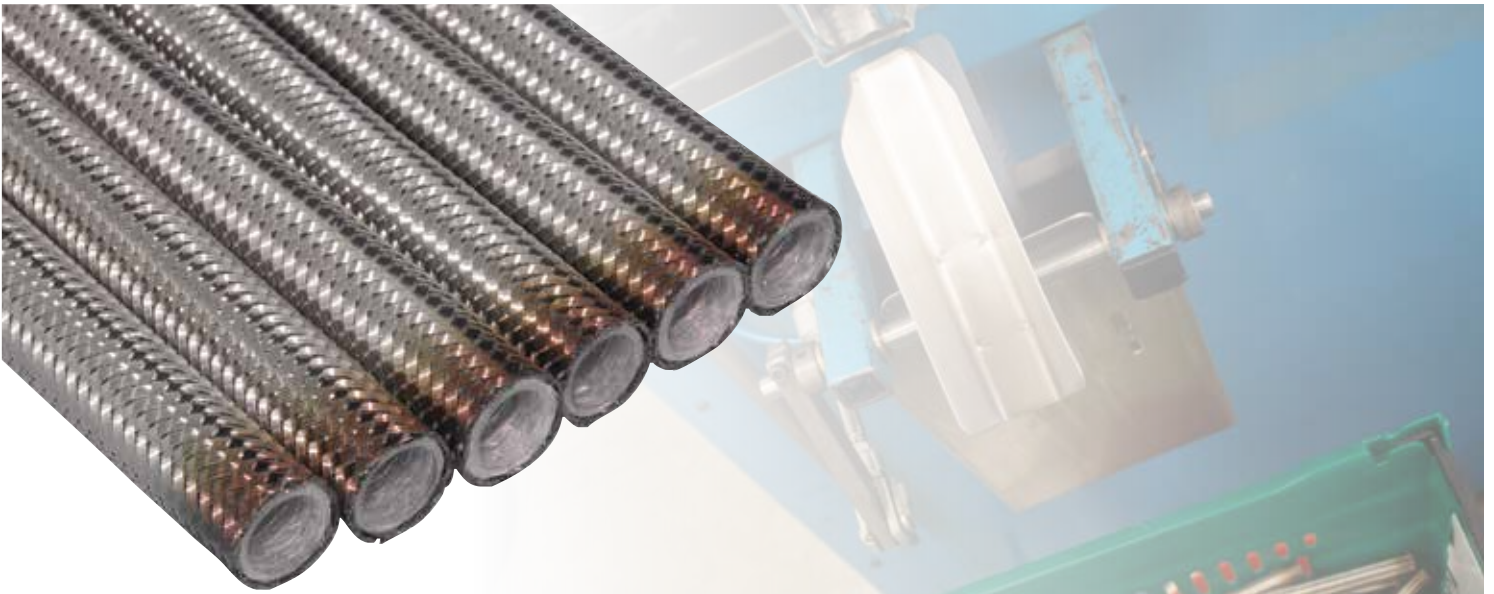

Self assembly customers who manufacture large numbers of hose assemblies require perfectly cut hose ends, to facilitate easy, quick assembly of end fittings.

Aflex Hose have developed an automatic hose cutting machine which is able to cut stainless steel braided hose lengths perfectly, without squashing or braid flare out.

This system is applicable to (uncovered) stainless steel braided grades of Smoothbore and Hyperline FX hose, in sizes up to 1" bore, in minimum cut lengths of 60mm (2<sup>3</sup>/<sub>8</sub>" ), no maximum length.

In addition, Aflex have developed a fully automated inspection system which checks the cut ends for diameters, ovality and protruding cut wire ends.

This inspection system is only applicable to regularly supplied large quantities of cut lengths and is limited to cut lengths which are less than 0.4 metres (16 inches) in length.

Automated washing equipment is available for short cut lengths, capable of achieving the required tolerance levels for particle size and count.

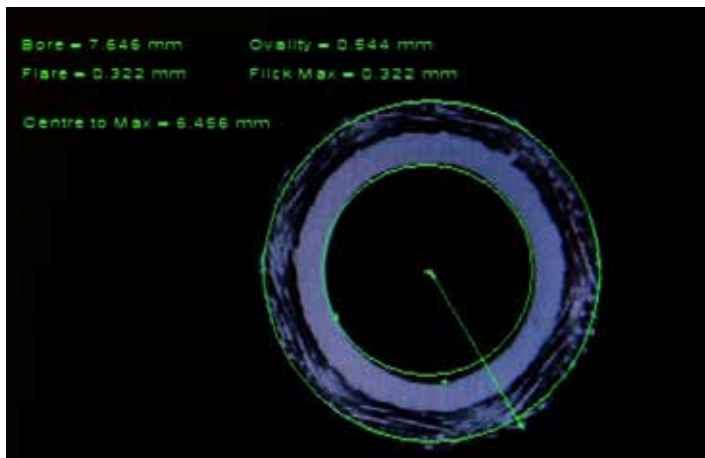

# HYPERLINE FX HOSE SPECIAL USAGE CONDITIONS

## **PTFE Hose-Use with Alkali Metals, Halogens and Halogen containing Chemicals**

PTFE hose liners react chemically with Fluorine, Chlorine Trifluoride and molten Alkali Metals.

When PTFE lined hose is used to carry Chlorine or Bromine, either as gasses or fluids, they will diffuse into and through the PTFE liner wall thickness. Trace quantities will then combine with atmospheric moisture to corrode any braid/rubber outer coverings.

Heavily halogenated chemicals, like Hydrogen Fluoride, Hydrogen Chloride, Phosgene (Carbonyl Chloride) Carbon Tetrachloride and other organic chemicals with a high halogen content can also be absorbed and transmitted through the PTFE liner tube.

## **Other “Penetrating” Fluids and Gases**

Sulphur Trioxide, Methyl Methacrylate, Caprolactam and Glacial Acetic Acid are some other chemicals which can be absorbed and transmitted through the PTFE liner tube wall.

Generally, however, as a hydrophobic (non-wetting) material, PTFE is very resistant to the absorption of chemicals. In some cases, PTFE has superior resistance to diffusion, for example to the diffusion of automotive fuels, in comparison with all other plastics and rubbers.

## **Gas/Fluid Cycling**

There are some applications where the fluid passing through the hose turns into a gas, then back into a fluid, then into a gas etc, in a cyclic sequence.

This is normally associated with changes in temperature and/or pressure. For complex reasons these conditions are extremely damaging to the hose liner, whatever material it is made from.

For example, hoses are sometimes used to pass steam, water, steam etc into rubber moulding presses, in order to heat the mould, then rapidly cool it before reheating in the next cycle. Hoses of all types fail rapidly in such an application and PTFE lined hoses are no exception.

Please contact Aflex Hose for further information if these conditions apply.

## **Connecting Assemblies for Use in Applications**

The lengths of hose assemblies and their configuration in use when connected into the application must always be in accordance with the Hose Configuration information at the end of this product literature.

When being connected for use in applications, the end fittings on hose assemblies must be connected to correct mating parts in the correct way, using the correct tools, spanners, clamps, nuts and bolts etc. The connections must be sufficiently tightened to ensure that the joint is leak free but not be over tightened as this can damage the sealing surfaces.

In applications involving the transfer through the hose of expensive or dangerous fluids or gases, the hoses and connections must be pressure tested in situ before being put in to service. This should be done with some harmless media to 1½ times the maximum working pressure of the hose assembly, as stated in the product literature.

If in doubt please contact Aflex Hose for advice.

## **Special Applications**

Aflex Hose PTFE lined hose products are not rated as suitable for use in the following, special applications:

All Radioactive Applications involving high energy radiation, including Gamma radiation (degrades PTFE)

All Medical Implantation Applications.

For Aerospace Applications, please contact Aflex for the appropriate hose choice.

## **Hyperline FX and Quality Assurance, Certification and Approvals**

### **BS EN ISO 9001:2015**

Aflex products are all manufactured in accordance with BS EN ISO 9001: Quality Management Systems independently assessed and registered by The British Standards Institution (BSI).

### **EN16643:2016**

Hyperline FX meets the requirements of EN16643 (SC), which include the electrical and electrostatic requirements of hose assemblies.

### **IATF16949:2016**

Aflex Hose Ltd manufactures PTFE flexible hose for the automotive industry in accordance with IATF16949 and is assessed and certified by The British Standards Institution (BSI).

### **ISO 14001:2015**

Aflex Hose Ltd have been successfully assessed to the requirements of ISO 14001, by the British Standards Institution (BSI). By gaining this accreditation Aflex Hose Ltd are demonstrating our commitment to reducing our impact on the environment.

### **ISO 45001:2018**

Aflex Hose Ltd have been successfully assessed to the requirements of ISO 45001, by the British Standards Institution (BSI). By gaining this accreditation Aflex Hose Ltd are demonstrating our commitment to the health and safety of our employees by consistently identifying and controlling risks to health and safety, reducing the potential for accidents, complying to relevant legislation and improving overall awareness throughout the business.

### **AS 9100D**

Aflex products for the Aerospace Sector are all manufactured in accordance with AS9100D Quality Management Systems and independently assessed and registered by The British Standards Institution (BSI).

### **FDA**

The Materials used to manufacture the natural PTFE Tube liner conforms to FDA 21 CFR 177.1550, and the antistatic PTFE liner conforms to FDA 21 CFR 178.3297.

### **Automotive Fuel Hose - SAE J1737**

Tested and approved for automotive fuel hose use in accordance with SAE J1737.

### **CE Marking (Europe only)**

Aflex has been assessed by The British Standards Institution (BSI) and found to comply with the Pressure Equipment Directive 2014/68/EU Conformity Assessment Module D1, approved to CE Mark applicable hose products, accompanied by a Hose Usage Data Sheet, and a Declaration of Conformity.

### **Attestations of Conformity to ATEX Directive 2014/34/EU (Potentially Explosive Atmospheres)**

Available for hose assemblies for components used in Gas Zones 1 & 2 and Dust Zones 21 & 22, when applicable.

### **Material Certification to EN10204**

Available for all the hose or hose assembly components.

### **Certificates of Conformity to BS EN ISO/IEC 17050**

Are available for all products.

# HOSE CONFIGURATION & LENGTH CALCULATIONS

## - FOR BEND RADIUS

### HOSE CONFIGURATION REQUIREMENTS

Hose Assemblies are usually connected at both ends in service. They may then either remain in a fixed, or static configuration or in a flexing, or dynamic configuration.

Whether static or dynamic, the First Rule concerning the configuration of the hose is that the bend radius of the hose must never be less than the Minimum Bend Radius (MBR) for the hose as listed in the relevant hose brochure.

The most common situation when this is likely to occur is when the hose is flexed at the end fitting, with stress being applied to the hose at an angle to the axis of the end fitting. Typically, this happens either because the length of the hose is too short, or because the weight of the hose plus contents creates a stress at an angle to the end fitting.

The Second Rule, therefore, if possible, is to design the configuration to ensure that any flexing in the hose takes place away from the end fittings.

#### (DYNAMIC) CONFIGURATION

**INCORRECT** - Hose too short

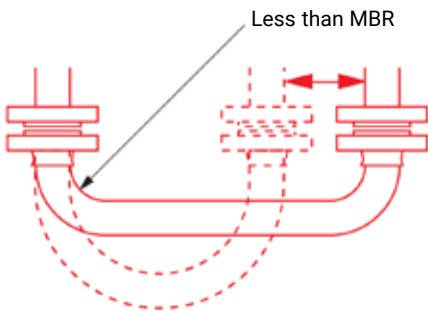

**CORRECT** - No flex at End Fittings

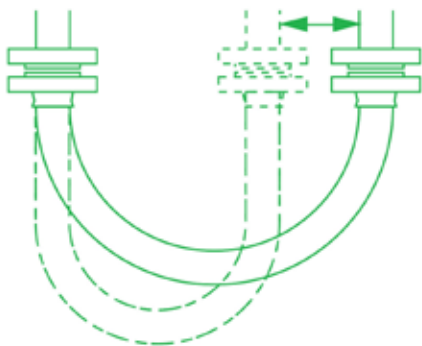

#### (STATIC) CONFIGURATION

**INCORRECT** - Weight of hose is at 90° to Axis of End Fittings

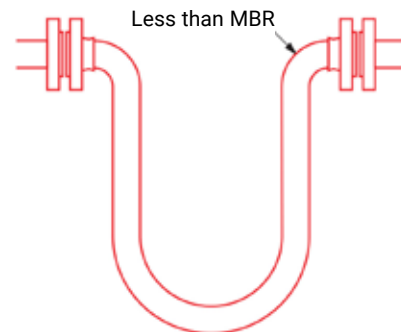

**CORRECT** - No flex at end fittings

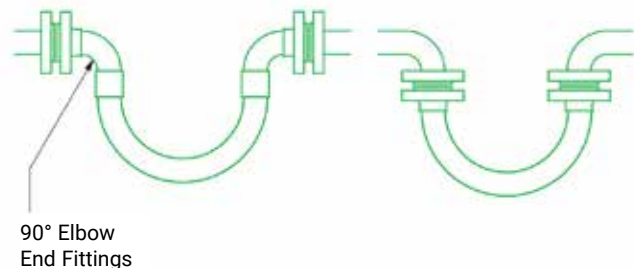

# HOSE CONFIGURATION & LENGTH CALCULATIONS

## - FOR ABRASION & TORQUE

The Third Rule is that the hose configuration should always be designed, and supported where necessary, to avoid any possibility of external abrasion.

In some cases, the length, configuration and angle of the hose can be designed to avoid abrasion. In others, static or moving support frames or support wheels are required.

**INCORRECT** - Abrasion against hose

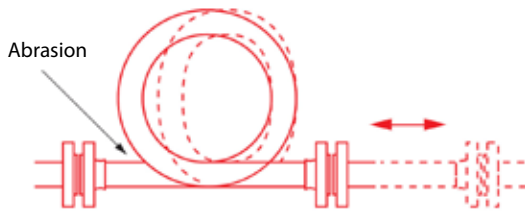

**INCORRECT** - Abrasion inside support

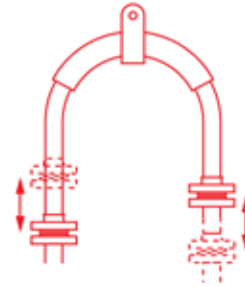

**CORRECT** - No hose abrasion

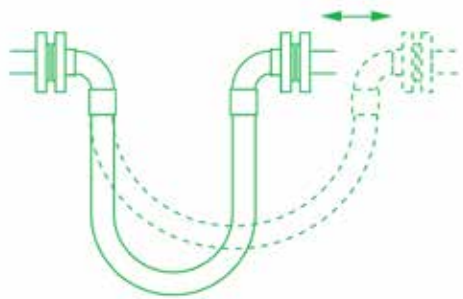

**CORRECT** - No abrasion over support

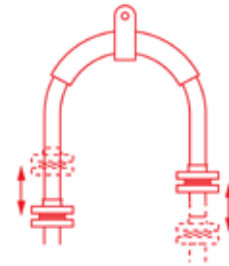

The Fourth Rule is that the hose must not be subjected to torque, either during connection, or as a result of the flexing cycle.

Torque (twist) in the hose can be applied during connection if the hose is accidentally twisted, or if the second end being connected is a screwed connection, and the hose is subjected to torque during final tightening.

In a flexing application, if any flexing cycle of the hose occurs in 3 dimensions instead of 2, then torque will also occur:

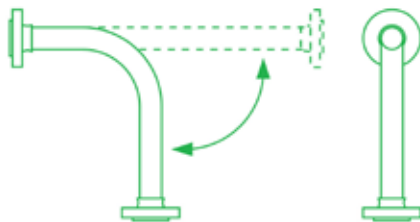

**CORRECT** - Flexing movement takes place in 2 dimensions

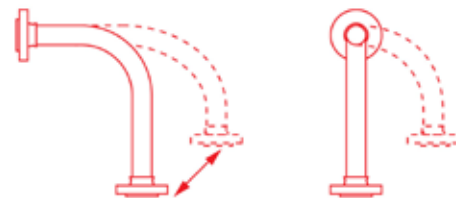
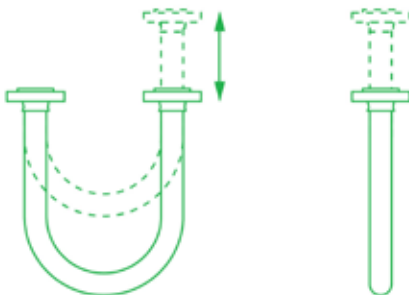

**INCORRECT** - Flexing movement takes place in 3 dimensions so torque is applied

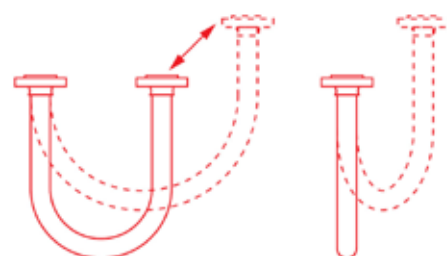

# HOSE CONFIGURATION & LENGTH CALCULATIONS

## - FOR LENGTH CALCULATIONS

### CALCULATING THE HOSE LENGTH

The formula for calculating the bent section of the hose length around a radius is derived from the basic formula that the circumference of a circle =  $2\pi R$ , where  $R$  = the radius of the circle, and  $\pi$  = a constant, = 3.142.

So, if the hose goes around a  $90^\circ$  bend, which is  $\frac{1}{4}$  of a full circumference, and the radius of the bend is  $R$ , then the length of the hose around the bend is =  $\frac{1}{4} \times 2\pi R$ . Or half way round, in a U-shape, =  $\frac{1}{2} \times 2\pi R$ .

#### Note :

In calculating the length of a hose assembly, the (non-flexible) length of the end fittings must be added in, also the length of any straight sections of hose, as in the following example:

#### Example :

To calculate the length for a 2" bore size hose with flange end fittings, to be fitted in a  $90^\circ$  configuration with one leg 400mm long, the other 600mm long.

$$\begin{aligned} \text{Length of Bent Section (yellow)} &= \frac{1}{4} \times 2\pi R \text{ (334)} \\ &= \frac{1}{4} \times 2 \times 3.142 \times 334 = 525\text{mm} \end{aligned}$$

$$\begin{aligned} \text{Length of top, Straight Section, including the top end fitting length} \\ &= 600 - 334 = 266\text{mm} \end{aligned}$$

$$\text{Length of bottom end fitting} = 66\text{mm}$$

$$\text{Total length of Hose Assembly} = 525 + 266 + 66 = 857\text{mm}$$

#### Things to consider

- A hose will normally take the longest radius available to it to go around a corner, not the MBR! Also - always remember to include the non-flexible end fitting lengths.
- In dynamic applications, remember to always calculate the lengths for the most extended configuration during the flexing cycle, not the least extended.
- If the configuration is simply too complex for calculation, then obtain a length of flexible tubing of some kind, mark on paper, or a wall, or floor, or both where the connection points will be relative to each other, scaled down if necessary, then manually run the flexible tubing between them with full radii round bends. Measure the extended length, then scale up if necessary to determine the approximate length of the hose.

If in doubt, consult Aflex Hose.

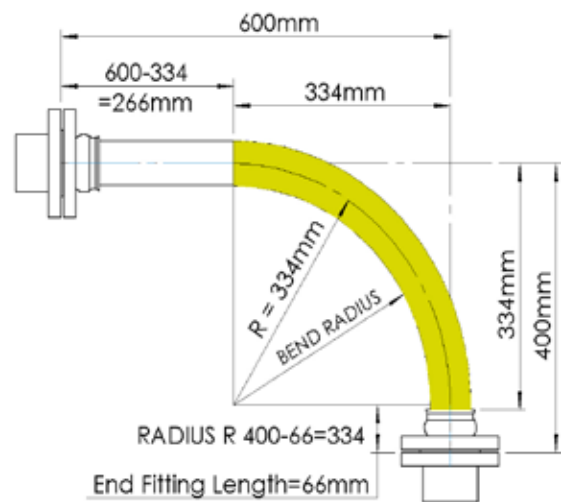
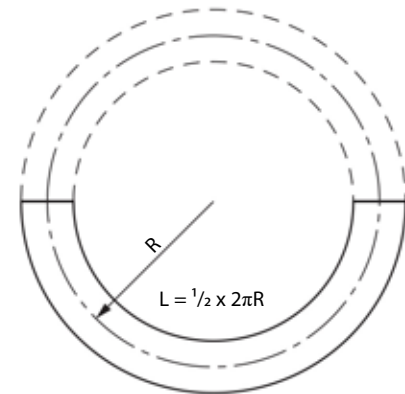
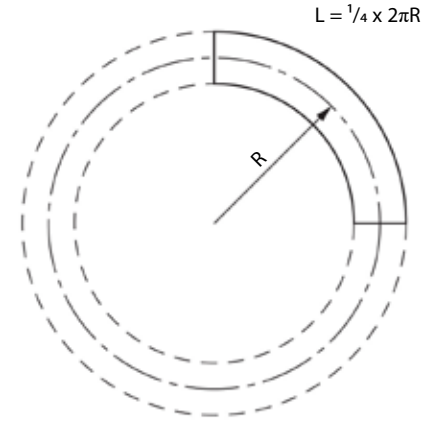

Note: The bend radius is measured to the inside edge of the hose, For the minimum bend radius refer to page 6.

# CONDITIONS OF SALE

## 1. Definitions

“Business Days” means a day (other than a Saturday, Sunday or public holiday) when banks in London are open for business.

“Buyer” means a customer of the Seller.

“Conditions” means these terms and conditions for the sale of goods or the supply of services or both.

“Contract” means a binding contract for the sale of goods or the supply of services or both made by the Seller and the Buyer.

“Emergency Call-out” means the call-out service for emergency breakdowns of the Buyer’s plant or equipment provided by the Seller to the Buyer in accordance with these Conditions in connection with a Contract for the performance of the Services.

“Factored Products” shall mean products which are supplied by Seller, but are not manufactured by Seller, and are purchased by Seller from another supplier or manufacturer.

“Force Majeure Event” means an event beyond the reasonable control of the Seller including but not limited to strikes, lock-outs or other industrial disputes (whether involving the workforce of the Seller or any other party), failure of a utility service or transport network, act of God, epidemic or pandemic, war, riot, terrorism, civil commotion, malicious damage, compliance with any law or governmental order, rule, regulation or direction, accident, breakdown of plant or machinery, fire, flood, storm, default of suppliers or subcontractors.

“Goods” means the goods agreed to be sold by the Seller to the Buyer as detailed in the Order Acknowledgment.

“Intellectual Property Rights” means all copyright, database rights, semi-conductor topography rights, design rights, trademarks, trade names, patents, domain names and any other intellectual property rights of a similar nature (whether or not registered) subsisting anywhere in the world.

“Losses” means:

- (a) any indirect, special or consequential loss or damage; or
- (b) loss of data or other equipment or property; or
- (c) economic loss or damage; or
- (d) incurring of liability for loss or damage of any nature whatsoever suffered by third parties (including in each case incidental and punitive damages); or
- (e) any loss of actual or anticipated profit, interest, revenue, anticipated savings or business or damage to goodwill.

“Seller” means Aflex Hose Limited.

“Services” means the services agreed to be supplied by the Seller to the Buyer as detailed in the Order Acknowledgment.

“Specification for Goods” means the specification for the Goods that is agreed in writing by the Seller and the Buyer.

“Specification for Services” means the specification for the Services that is agreed in writing by the Seller and the Buyer.

## 2. Interpretation of Contracts

(a) The Uniform Law on International Sales, the United Nations Convention on Contracts for the International Sale of Goods and the international rules for the interpretation of trade terms prepared by the International Chamber of Commerce (INCOTERMS) shall be excluded. The construction, validity and performance of all Contracts shall be governed by English law and, without prejudice to the right of the Seller to take action against the Buyer in any other court of competent jurisdiction, any claim or dispute arising from the Contracts shall be subject to the exclusive jurisdiction of and be determined by the courts of England. The taking of proceedings in any one or more jurisdiction shall not preclude the Seller from taking proceedings in any other jurisdiction, whether concurrently or not, to the extent permitted by the law of such other jurisdiction.

(b) The complete or partial invalidity or unenforceability of any provision in a Contract shall in no way affect the validity or enforceability of the remaining provisions in a Contract. Any such provision shall be deemed to be modified to the minimum extent necessary to make it valid or enforceable. If such modification is not possible, the relevant provision shall be deemed severed subject to such consequential modification as may be necessary for the purpose of such severance.

(c) The headings used herein are for convenience only and shall not affect construction.

(d) Words in the singular include the plural and in the plural include the singular.

(e) Reference to a Condition is to a Condition of these Conditions unless the context requires otherwise.

## 3. Formation of Contracts and Application of Terms and Conditions

(a) All Contracts shall be deemed to incorporate these Conditions.

(b) Any variation to these Conditions shall have no effect unless expressly agreed in writing and signed by an authorised signatory of the Seller and any variation of a Contract shall have no effect unless it is in writing and signed by the Seller and the Buyer (or their authorised representatives).

(c) A prospective Buyer shall place its order for goods or services (or both) by completing the Seller’s purchase order standard form, if applicable, or by submitting its own purchase order form (in either case, such form is the “Purchase Order”). Each Purchase Order shall be deemed to be an offer by the prospective Buyer to buy the goods or services (or both) of the Seller that are identified in the Purchase Order subject to these Conditions.

(d) The Purchase Order shall only be deemed to be accepted when the Seller issues to the prospective Buyer an order acknowledgement form which indicates acceptance of the prospective Buyer’s offer on these Conditions (the “Order Acknowledgment”). A Contract between the Seller and the Buyer shall come into existence at the time and on the date when the Seller delivers the relevant goods or services (or both) to the Buyer.

(e) The Contract shall constitute the entire agreement between the Seller and the Buyer and the Buyer acknowledges that it has not relied on any statement, promise or representation made or given by or on behalf of the Seller that is not set out in the Contract.

(f) The Buyer shall ensure that the description of the goods or services (or both) ordered which is contained in its Purchase Order and any applicable specifications is complete and accurate.

(g) These Conditions apply to the Contract to the exclusion of all other terms and conditions that the Buyer shall seek to impose or incorporate, or which are implied by trade, custom, practice or course of dealing. These Conditions may be extended by additional terms and conditions issued by the Seller in writing and confirmed in the Order Acknowledgment.

## 4. Quotations and Purchase Orders

(a) Any quotation issued by the Seller shall not constitute an offer and is given on the basis that no Contract shall come into existence unless and until the Seller despatches an Order Acknowledgment to the Buyer.

(b) Any quotation issued by the Seller is valid for a period of 5 Business Days for delivery dates and 30 Business Days for prices only after the date of its issue, provided that the Seller has not previously withdrawn it by notice in writing to the Buyer.

(c) Subject to Condition 4(d), any Purchase Order accepted by the Seller shall be accepted on the basis that the price for the goods or services (or both) shall be that set out in the Seller’s quotation on condition that the Seller’s quotation is within its period of validity and notice of withdrawal in writing has not been issued by the Seller at the time of acceptance.

(d) The Seller reserves the right to give in writing notice of the withdrawal of a quotation at any time within the period of validity of the quotation and before the Contract is formed. In the event that the Seller changes the price of any of the goods or services (or both) offered for sale or supply, any existing quotation in respect of those goods or services (or both) shall be deemed to be automatically withdrawn and the Seller shall issue a new quotation to the prospective Buyer.

(e) The prices stated in the Seller’s quotations are exclusive of VAT.

(f) All Purchase Orders placed by a prospective Buyer shall be placed by fax, post or e-mail, or, where agreed in advance in writing by the Seller, by telephone or Seller’s electronic system for prospective Buyers to place orders and make payments.

## SALE OF GOODS

### 5. The Goods

(a) The Goods are described in the Specification for Goods. The Goods shall comply with the Specification for Goods in material respects. Any stated dimension or weight set out in the Specification for Goods is an estimate only.

(b) All performance figures, descriptions (other than any description set out in the Specification for Goods), drawings and samples of Goods are approximate only being intended to serve merely as a guide. The Seller shall not be liable for their accuracy and they shall not form part of the Contract. No Contract shall be a contract by sample.

(c) The Seller may alter the Specification for Goods:

- (i) for the purpose of making changes to the Goods which it can establish to the reasonable satisfaction of the Buyer constitute improvements to the Goods or;
- (ii) if required by any applicable statutory or regulatory requirements.

(d) The Seller may increase the price of the Goods by giving notice in writing to the Buyer at any time before delivery, to reflect any increase in the cost of the Goods to the Seller that is due to:



# CONDITIONS OF SALE CONTINUED

(i) any factor beyond the control of the Seller (including foreign exchange fluctuations, increases in taxes and duties, and increases in the cost of acquiring or manufacturing the Goods;

(ii) any request by a Buyer to change the delivery date(s), quantities or types of Goods ordered, or the Specification for Goods; or

(iii) any delay caused by any instructions of the Buyer in respect of the Goods or failure by the Buyer to give the Seller adequate or accurate information or instructions in respect of the Goods.

(e) All drawings, designs, and quotations for which goods are not subsequently ordered by the Buyer shall remain the property of the Seller and be treated as confidential by the Buyer and not used in any way. The Seller shall have no liability in relation to any such drawings, designs or quotation.

(h) The Buyer accepts that Seller is not an expert in the technical features which apply to Factored Products and/or their use in application. Seller's only obligation will be to pass on to the Buyer all the written information which Seller has itself received regarding the Factored Product, but the Buyer shall be responsible for ensuring that this and any other necessary Factored Product information is obtained and is reviewed and will decide solely if such data is sufficient to ensure that the Factored Product is fit for purpose in the intended usage application. If any application requirements apply which are not fully covered by the information which the Buyer can obtain, then the Buyer undertakes not to use or supply the Factored Product for use in that application. The Buyer is also responsible for ensuring that the Factored Product will not be subjected to levels of usual or accidental physical abuse in service which would cause the Factored Product to fail. The Buyer agrees and acknowledges that Seller, its officers, directors, employees, affiliates and representatives shall not be held liable for any claims or obligations arising out of the Buyer's failure to fulfil any or all of its responsibilities set forth in this clause 8(h), and hereby agrees to indemnify and hold Seller its officers, directors, employees, affiliates and representatives fully harmless from any and all claims that may arise in regard to Factored Products. If the Buyer has any doubts concerning these or any other usage conditions and limitation or safety parameters, the Buyer shall consult Seller and request a written response to any queries.

## 5A. UNTESTED HOSE SUPPLIES FOR SELF-ASSEMBLY BY BUYERS ("SAC")

(a) Unless otherwise specified in writing by Seller, "loose" hose supplied (without end fittings attached) for self-assembly by Buyer (who will cut the hose to length and attach end fittings to make up Hose Assemblies for their own use, or for sale to their own customers) will not be pressure tested by Seller before supply. Such hydrostatic testing of the hose and the end fitting attachment will be the sole responsibility of the Buyer and Buyer warrants and represents that it shall carry out such hydrostatic pressure testing on all of its SAC hoses purchased from Seller, adhering to the maximum working pressure (MWP) and safety factor of the hose assembly as specified in the relevant Seller product brochure (as may be amended from time to time).

(b) When pressure testing braided hoses with a plastic or rubber outer cover, the cover will mask any signs of leakage for a time. The Buyer agrees and acknowledges that in respect of all SAC hoses, after the hydrostatic pressure test, it is further required to test each covered hose assembly with an internal helium gas pressure of 30 Bar (450 psi) for hose sizes up to 1" and 15 Bar (225 psi) for hose sizes above 1", with the hose assembly immersed in water to enable leak detection by gas bubbles, for a minimum test period of 5 minutes.

(c) The Buyer agrees and acknowledges that in respect of all SAC hoses, Buyer alone shall determine and approve the design suitability of the hose assembly for its intended use before supply by Seller and that it shall indemnify and hold Seller fully harmless from any and all claims and losses, whether direct or indirect arising from design suitability for a SAC hose.

## 5B. UNTESTED HOSE ASSEMBLIES

If Seller agrees under a Purchase Order to attach non-standard end fittings to hose assemblies which the Buyer supplies to Seller, Buyer acknowledges and agrees that, in some instances, it is not possible to connect such non-standard fittings to the Seller pressure testing system. In such cases Buyer agrees that Seller shall be entitled, on giving notice to Buyer, not to test such Goods. Seller shall label the hose assembly with a warning that it requires pressure testing before use. The Buyer agrees and acknowledges that Seller shall have no liability whatsoever if the Buyer does not comply with the warning that requires pressure testing before use, and agrees to fully indemnify and hold Seller fully harmless from any and all claims arising from any use by Buyer or onward sale by Buyer of such untested hose assemblies.

## 6. Despatch and Delivery

(a) For the purposes of this Condition 6, the "Goods" shall mean the Goods in their entirety where delivery is not by instalments or, where delivery is by instalments, each instalment of the Goods.

(b) Unless otherwise agreed in writing by the Seller, delivery of the Goods shall take place at the location stated by the Seller in the Order Acknowledgement (the "Point of Delivery").

(c) Any stated delivery date is an estimate and time for delivery shall not be of the essence. The Seller will use reasonable endeavours to meet any stated delivery date.

If no date for delivery is specified, delivery shall be within a reasonable time.

**(d) THE SELLER SHALL NOT BE LIABLE FOR ANY LOSSES (AS DEFINED), CAUSED DIRECTLY OR INDIRECTLY BY ANY DELAY IN THE DELIVERY OF THE GOODS EVEN IF CAUSED BY THE SELLER'S NEGLIGENCE.**

**(e) ANY DELAY IN THE DELIVERY OF THE GOODS SHALL NOT ENTITLE THE BUYER TO TERMINATE OR RESCIND THE CONTRACT UNLESS SUCH DELAY EXCEEDS ONE HUNDRED AND EIGHTY (180) DAYS.**

(f) Delivery of the Goods shall be completed on the arrival of the Goods at the Point of Delivery. Risk in the Goods shall pass to the Buyer on completion of delivery of the Goods.

(g) Except insofar as the Contract expressly provides otherwise, standard carriage and packaging is excluded in the price. Seller may select the method of delivery, and charge the Buyer for the cost of carriage. Where the Goods are to be delivered at the Buyer's request by any special or express means, the Seller will charge the Buyer the full cost of carriage. When any special packaging is required (whether at the Buyer's request or because the Seller considers special packaging to be necessary), then the Seller will charge the Buyer the full cost of such packaging.

(h) In contracting for carriage and/or insurance of the Goods in transit, if required by the Contract, the Seller shall be deemed to act solely as agent of the Buyer.

(i) The Buyer must:

(i) examine the Goods on delivery;

(ii) notify the Seller and any carrier in writing of any shortage or damage within four (4) Business Days after the date of delivery and in respect of non-delivery within ten (10) Business Days after the Goods would in the ordinary course of events have been received; and

(iii) in the case of short or damaged delivery give the Seller a reasonable opportunity to inspect the Goods,

otherwise Goods shall be deemed accepted by the Buyer.

**(j) ANY LIABILITY OF THE SELLER FOR NON-DELIVERY OF THE GOODS SHALL BE LIMITED TO EITHER DELIVERING THE GOODS WITHIN A REASONABLE TIME OR ISSUING A CREDIT NOTE AT THE PRO RATA CONTRACT RATE AGAINST ANY INVOICE RAISED FOR SUCH GOODS.**

(k) The Seller may deliver the Goods by instalments, each instalment to be deemed to be a separate Contract. Without limiting the other provisions herein, no failure or defect in delivery in respect of any Contract or instalment shall entitle the Buyer to repudiate or cancel any other Contract or instalment.

(l) If for any reason the Buyer fails to accept delivery of any of the Goods within two (2) Business Days of the Seller giving notice to the Buyer that the Goods are ready, or the Seller is unable to deliver the Goods on time because the Buyer has not provided appropriate instructions, documents, licences or authorizations for the Goods when they are tendered by the Seller for delivery then, except where such failure is caused by a Force Majeure Event:

(i) delivery of the Goods shall be deemed to have been completed at 9.00 am on the second (2nd) Business Day after the day on which the Seller notified the Buyer that the Goods were ready;

(ii) risk in the Goods shall pass to the Buyer on completion of delivery; and

(iii) the Seller may store the Goods until delivery takes place, whereupon the Buyer shall be liable for all related costs and expenses (including, without limitation, storage and insurance). The Buyer shall be responsible for all Losses incurred by the Seller where the Buyer fails to accept delivery of Goods.

(m) If ten (10) Business Days after the Seller giving notice to the Buyer that the Goods were ready the Buyer has not accepted delivery of the Goods, the Seller may resell or otherwise dispose of part or all of the Goods.

(n) Due to the nature of the production of PTFE hose, Seller reserves the right to call a Purchase Order for bulk hose complete in the following situations: (a) if a product is a standard Seller product (as listed in Seller's product brochures) a figure of +10% of original order quantity can be supplied. If the product is a non-standard product and outside the Seller's standard product range the figure of +/- 10% of the original order quantity can be supplied. Goods supplied within these parameters would result in the Purchase Order being complete and delivery satisfied.

## 7. Title

(a) The title in the Goods supplied shall not pass to the Buyer until receipt by the Seller in cleared funds of payment in full (including payment of any default interest) for:

(i) the Goods; and

(ii) any other goods or services that the Seller has supplied to the Buyer and in respect of which payment is due.

(b) Until the title in the Goods passes to the Buyer the Buyer shall:

(i) be a bailee of the Goods;

# CONDITIONS OF SALE

(ii) store the Goods separately from all other goods held by the Buyer so that the Goods remain readily identifiable as the Seller's property;

(iii) not remove, deface or obscure any identifying mark or packaging on or relating to the Goods;

(iv) not fix or annex the Goods to or merge the Goods with any part of the Buyer's premises, plant or equipment without the Seller's prior consent in writing;

(v) maintain the Goods in satisfactory condition;

(vi) keep the Goods insured between the passing of risk in the Goods and title to the Goods against all risks with a reputable insurer which has been approved by the Seller for their full price, and ensure that the Seller's interest in the Goods is noted on the insurance policy until title in the Goods passes to the Buyer. If the Buyer fails to insure the Goods the Seller may do so instead on behalf of the Buyer, who shall reimburse the Seller on demand. Until title in the Goods passes to the Buyer, the Buyer shall hold in trust for the Seller the policy and proceeds of insurance;

(vii) notify the Seller immediately if it becomes subject to any of the events listed in Conditions 21(a)(iv) to 21(a)(x);

(viii) give the Seller such information relating to the Goods as the Seller may require from time to time; and

(ix) not dispose of, charge or encumber the Goods or any interest in the Goods or purport to do so,

but the Buyer may resell the Goods to an independent third party on arm's length terms in the ordinary course of its business.

(c) If before title to the Goods passes to the Buyer the Buyer becomes subject to any of the events listed in Conditions 21(a)(iv) to 21(a)(x), or the Seller reasonably believes that any such event is about to happen and gives notice to the Buyer accordingly, then, provided that the Goods have not been resold, or irrevocably incorporated into another product, and without limiting any other right or remedy the Seller may have, the Seller may at any time require the Buyer to deliver up the Goods and, if the Buyer fails to do so promptly, the Seller may enter any premises of the Buyer or of any third party where the Goods are stored in order to recover them.

## 8. Warranty for Goods

(a) Subject to Condition 8(b), the Seller warrants that on delivery, and for a period of 24 months (12 months for all Hose Assemblies which are "ETH" ("Electrical Trace Heated") Grade or are Factored Products) from the date of delivery the Goods shall:

(i) conform with the Specification for Goods; and

(ii) be free from material defects in material or workmanship.

(b) In respect of Goods which are packages or electrically or electronically controlled or actuated Goods, the Seller warrants that on delivery, and for a period of 12 months from the date of delivery such Goods shall:

(i) conform with the Specification for Goods; and

(ii) be free from material defects in material or workmanship.

(c) Subject to the remainder of this Condition 8, the Seller warrants that if (i) the Buyer provides the Seller with written notification within forty-eight (48) hours of discovering a suspected defect, (ii) if requested by Seller (after Buyer has provided all relevant information requested by Seller in respect of the suspected defective Good(s)), the Buyer returns the Goods within the relevant warranty period for such Goods (as set out in either Condition 8(a) or 8(b)) and (iii) on the Seller's examination such Goods prove defective as to material or workmanship or as to compliance with the relevant Specification for Goods the Seller shall:

(i) give notice to the Buyer that such Goods prove defective as to material or workmanship or as to compliance with the relevant Specification for Goods; and

(ii) following giving notice thereof to the Buyer;

(aa) with respect to Goods which have been manufactured by the Seller, make good the defect without charge by (at the Seller's option) repairing the defective Goods, replacing defective components of the defective Goods, or replacing the defective Goods (in their entirety) as the Seller in its discretion considers appropriate; or

(bb) with respect to Goods which have been supplied, but not manufactured by the Seller, and to the extent that it is entitled to do so, assign or at its discretion use its reasonable endeavours otherwise to make available to the Buyer, at the Buyer's expense and on the basis of an indemnity (secured if appropriate) against all Losses that may be incurred by the Seller in relation thereto, the benefit of any obligations and warranties which relate to such defect which the Seller may be owed by the manufacturer and/or supplier of the Goods or any part or component thereof.

(d) The above warranties shall apply except where the defect in the Goods:

(i) has been caused wholly or partly by deterioration of the Goods which is necessarily incidental to the transit of the Goods;

(ii) has been caused while the Goods were at the Buyer's risk by:

(aa) wilful default or negligence by the Buyer or its employees, agents, consultants or subcontractors;

(bb) the occurrence of an accident;

(cc) failure by the Buyer to follow the Seller's instructions in relation to the storage, use, installation, commissioning or maintenance of the Goods;

(dd) failure by the Buyer to follow good trade practice;

(ee) the Buyer altering or repairing such Goods without the consent in writing of the Seller;

(ff) fair wear and tear, negligence or by any abnormal conditions.

(e) Except as provided in this Condition 8, the Seller shall have no liability to the Buyer in respect of the Goods' failure to comply with the warranties set out in this Condition 8.

(f) The terms of these Conditions shall apply to any repaired or replacement Goods supplied by the Seller under Condition 8(c).

(g) The above warranties shall not apply to consumable items with a limited life expectancy.

## 9. Returns

(a) The Seller shall not refund the Buyer for any amounts paid by the Buyer in the event that the Buyer returns the Goods (or part thereof) except with the Seller's prior consent in writing. Where such consent is given, the Buyer agrees to pay to the Seller a minimum handling charge of thirty per cent (30%) of the invoiced value.

(b) To qualify for any refund, the Goods must be appropriately packed to protect them from being damaged in transit and be received by the Seller in a saleable condition within twenty-two (22) Business Days of delivery to the Buyer. The term "Goods" within this Condition 9(b) has the meaning set out within Condition 6(a).

## 10. Instructions and Health and Safety at Work

(a) The Buyer shall observe strictly the provisions of the Seller's instructions in writing regarding use and application of the Goods together with any revisions thereof and shall ensure that any person other than the Buyer who acquires or has access to the Goods is furnished with and observes such instructions.

(b) The Buyer shall be solely responsible for and shall keep the Seller indemnified against all Losses incurred by the Seller in relation to any use of the Goods other than in strict accordance with the Seller's installation, operating, and maintenance instructions.

(c) The Buyer agrees and acknowledges that for any intended application of the Good(s) in which special conditions apply which are not defined, or not defined sufficiently in the Seller's product brochure, the Buyer shall write to Seller requesting written advice relating to any usage limitations resulting from its special uses or conditions. The Buyer shall be fully liable and responsible for ensuring the design suitability and safety of the Goods in their intended applications, giving particular consideration to any special condition relating to, but not restricted to the chemical and electrostatic compatibility of the fluids or gases passing through, the possibility of diffusion of fluid or gases through the PTFE hose lining, the possibility of external corrosive conditions, the types and likelihood of excessive mechanical abuse, such as abrasion (internal or external), crushing, excessive flexing or vibrations, etc. and any excessive temperature and/or pressure "pulsing" conditions, or any other condition which may cause premature hose failure. The Buyer shall consider and take account of the degree of risk involved in any potential Goods failure, including the provision of adequate protection in the event of any risk to any persons. In applications where any type of Goods failure would lead to financial losses if the Goods are not replaced immediately, the Buyer agrees and acknowledges that it shall be the Buyer's responsibility to order and hold in stock spare Goods accordingly. The Buyer shall advise Seller in writing at the time of placing the enquiry and on any Purchase Order if there are any special requirements for the Good(s), including special cleaning, or drying, or extra testing requirements which are in addition to normal industrial standards. Mere notice of such additional requirements to Seller however, does not relieve the Buyer of its responsibility and liability for ensuring adequate measures are taken or are in place for such applications nor does the mere notification burden nor transfer to Seller any Buyers' liability that the Buyer has for such intended application.

## 11. Export Sales

(a) Where goods are supplied for export from England the following additional Conditions shall apply, and where there is any conflict between the provisions of this Condition 11 and any other Conditions, the provisions of this Condition 11 shall prevail.

(b) Charges for the cost of export deliveries and documentation shall be as stated in the Contract.

(c) Except where specifically agreed in writing to the contrary, delivery to a Buyer outside of the United Kingdom will be in accordance with the "Ex Works" rule from the international rules for the interpretation of trade terms prepared by the International Chamber of Commerce (INCOTERMS). In the case of deliveries outside of the United Kingdom the Seller does not accept any liability for damage to the Goods during transit, or marine or war risks unless otherwise specifically agreed by the Seller.

(d) The party which is exporting, in the case of exports, or the party which is importing, in the case of imports, will be responsible for obtaining all necessary licences, (or other governmental authorisations required in connection with any export, re-export, or imports, as the case may be, under the Contract. The parties will co-operate with each other in securing any such licenses or authorisations as may be required and each

# CONDITIONS OF SALE CONTINUED

will provide such statements, certificates and assurances regarding transfer, use, disposition, end-use, source of supply, nationalities and re-export of the Goods as may be required in connection with each party's application for any required license or governmental authorisation.

(e) Any government fees or charges in connection with obtaining such licenses or authorisations will be the responsibility of the party which is exporting, in the case of exports, and the party which is importing, in the case of imports, the Goods.

(f) The Buyer undertakes not to:

(i) offer the Goods for resale in any country where the Buyer knows the export of the Goods is prohibited by the US Government, the UK Government, the UN, the EU or any other relevant organisation; or

(ii) offer to sell the Goods to any person the Buyer knows or suspects will subsequently resell the Goods into a country where export of the Goods is prohibited by the US Government, the UK Government, the UN, the EU or any other relevant organisation.

(g) The Buyer will indemnify the Seller for all liabilities, loss, damages, costs and expenses awarded against or incurred by the Seller arising out of in connection with any breach of the Buyer's obligations contained in Condition 11(g).

(h) The Buyer agrees to provide the Seller with any information the Seller reasonably requires concerning the destination and use of the Goods, to allow the Seller to comply in full with any relevant export legislation.

## **SUPPLY OF SERVICES**

### **12. Period of Supply**

(a) Unless otherwise specified in the Order Acknowledgment, the agreement for the supply of the Services shall be for a period of one (1) year from the date the Seller issues an Order Acknowledgment to the Buyer in accordance with Condition 3 (d) (the "Term for Services").

(b) The Seller reserves the right to increase its price for the Services at any time during the Term for Services. The Seller will give the Buyer notice in writing of any such increase not less than eight (8) weeks before the proposed date of the increase. If such increase is not acceptable to the Buyer, it shall notify the Seller in writing within two (2) weeks of the Seller's notice and the Seller shall have the right, without limiting its other rights or remedies, to terminate the Contract by giving four (4) weeks' notice in writing to the Buyer.

### **13. Performance of Services**

(a) The Seller agrees to provide the Services in accordance with the Specification for Services in all material respects, and to supply as necessary spare or replacement parts and/or consumables, to the Buyer's plant and/or equipment at the site(s) specified in the Seller's Order Acknowledgment.

(b) If the Seller agrees to supply spare or replacement parts and/or consumables, such supply will be strictly on the basis of these Conditions.

(c) Any stated performance date is an estimate only and time for performance of the Services shall not be of the essence. The Seller shall use reasonable endeavours to meet any stated performance date. If no date for performance is specified, the Services shall be performed within a reasonable time.

**(d) THE SELLER SHALL NOT BE LIABLE FOR ANY LOSSES (AS DEFINED), CAUSED DIRECTLY OR INDIRECTLY BY ANY DELAY IN THE PERFORMANCE OF THE SERVICES EVEN IF CAUSED BY THE SELLER'S NEGLIGENCE.**

**(e) SUBJECT TO CONDITION 13(G), ANY DELAY IN THE PERFORMANCE OF THE SERVICES SHALL NOT ENTITLE THE BUYER TO TERMINATE OR RESCIND THE CONTRACT UNLESS SUCH DELAY EXCEEDS ONE HUNDRED AND EIGHTY (180) DAYS.**

**(f) SUBJECT TO CONDITION 13(G), THE SELLER'S LIABILITY FOR NON-PERFORMANCE OF SERVICES SHALL BE LIMITED TO EITHER PERFORMING THE SERVICES WITHIN A REASONABLE TIME OR ISSUING A CREDIT NOTE AT THE PRO RATA CONTRACT RATE AGAINST ANY INVOICE SUBMITTED TO THE BUYER FOR THE SERVICES.**

(g) If the Seller's performance of the Services is prevented or delayed by the Buyer or by the failure of the Buyer to perform any of its obligations under the Contract ("Buyer Default") then upon the Seller giving the Buyer notice in writing that there has been a Buyer Default:

(i) the Seller shall without limiting its other rights or remedies have the right to suspend performance of the Services until the Buyer remedies the Buyer Default and to rely on the Buyer Default to relieve it from the performance of any of its obligations to the extent that the Buyer Default prevents or delays the Seller's performance of the Services;

(ii) the Seller shall not be liable for any Losses incurred by the Buyer arising directly or indirectly from the Seller's failure or delay in performing the Services; and

(iii) the Buyer shall reimburse the Seller on demand for all Losses incurred by the Seller arising directly or indirectly from the Buyer Default.

(h) The Seller reserves the right, at the Seller's discretion, to employ subcontractors to perform all or any part of the Services (including, without limitation, to commission, install, maintain or repair any parts or equipment) on behalf of the Seller.

(i) The Seller warrants that in providing the Services it will exercise reasonable care and attention and that it will comply with all applicable laws and regulations. However the Seller excludes liability for all Losses arising directly or indirectly out of any failure or diminution in performance of the Buyer's plant or equipment caused by the plant or equipment, or any part thereof:

(i) being used or operated otherwise than in accordance with any applicable installation, maintenance or operational instructions; or

(ii) being used or operated otherwise than in accordance with the Seller's instructions or recommendations; or

(iii) having been adjusted, changed or altered in any way by the Buyer or any third party since the date of installation or commissioning of the plant or equipment or the date of the immediately preceding visit by the Seller's employee or sub-contractor.

(j) The Buyer warrants to the Seller that the Buyer's plant and equipment is supplied with water at a quality that complies with BS2486 and is compliant with any additional requirements in writing notified by the Seller to the Buyer in respect of the Buyer's plant and equipment. The Seller excludes all liability for Losses arising directly or indirectly out of any failure or diminution in performance of the Buyer's plant or equipment or any part thereof which is caused directly or indirectly by a breach by the Buyer of this warranty.

(k) The Seller reserves the right to replace at the Buyer's cost the Buyer's plant or equipment or any part thereof which is unserviceable or inefficient as the Seller considers reasonably necessary in order to fulfil its obligations to provide the Services in accordance with the specification set out in the Order Acknowledgment.

(l) Alternatively, the Seller may charge the Buyer for the reconditioning of any part of the Buyer's plant or equipment that, in the reasonable opinion of the Seller, cannot be suitably or economically repaired on site. The Seller will provide the Buyer with an estimate of reconditioning charges for each item and if the Buyer does not agree to have the item(s) reconditioned, the Seller reserves the right to amend the scope of the Services as in its absolute discretion it considers necessary.

### **14. Access to Buyer's Site(s)**

(a) The Buyer shall co-operate with the Seller in all matters relating to the Services, and shall provide the Seller with such information as the Seller may reasonably require in order to perform the Services. The Buyer shall ensure that such information is accurate in all material respects.

(b) The Buyer shall obtain and maintain any necessary licences, permissions, and consents which may be required before the date upon which the Services are due to start.

(c) The Buyer shall permit the Seller, its employees, agents, consultants and subcontractors full and free access to the Buyer's site(s) and to the Buyer's plant and equipment which is the subject of the Contract, subject to the Seller and its employees, agents, consultants and subcontractors complying with the Buyer's reasonable requirements as to site safety and security. If, at the time of any pre-arranged visit the Seller's employees, agents, consultants and subcontractors are unable to gain access to the Buyer's site(s) or plant or equipment in order to supply the Services, the Seller reserves the right to charge for the time spent attending at the Buyer's site(s) and for the cost of carrying out any subsequent visit.

(d) If reasonably required by the Seller, the Buyer shall make available to the Seller a secure storage area at the Buyer's site(s) for storage of the Seller's service equipment and shall keep all materials, equipment, documents and other property of the Seller (the "Seller Service Equipment") in such storage area in safe custody and at the Buyer's risk. The Buyer shall not dispose of the Seller Service Equipment other than in accordance with the Seller's instructions in writing.

(e) Prior to any visits by the Seller's employees, agents, consultants or subcontractors, the Buyer will:

(i) strip back any pipe lagging;

(ii) supply and erect suitable scaffolding (if required) to allow working access to the Buyer's plant and equipment; and

(iii) supply any necessary lifting equipment and required operators.

(f) Following any visits by the Seller's employees, agents, consultants or subcontractors, the Buyer will be responsible for the reinstatement of any pipe lagging and the dismantling of any scaffolding erected.

(g) The Buyer will provide the Seller's employees, agents, consultants and subcontractors with all specialist safety clothing or equipment as may be necessary to meet the Buyer's health and safety and environmental rules (excluding hard hat, safety glasses, overalls and protective shoes which will be provided by the Seller).

(h) The Buyer will procure that the Seller's employees, agents, consultants and subcontractors are covered by the Buyer's third party liability insurance policy of an amount of not less than three million pounds (£3,000,000) per occurrence whilst such employees or subcontractors are on the Buyer's site(s).

# CONDITIONS OF SALE

(i) Emergency Call-outs are intended for genuine emergency breakdown of the Buyer's plant or equipment which is the subject of the Contract only and will be charged by the Seller to the Buyer at the appropriate daily rate specified in the Order Acknowledgment. Each Emergency Call-out will be charged as one (1) additional day of Services over and above the number of days specified in the Order Acknowledgment for the supply of the Services.

(j) The Buyer acknowledges and agrees that the Seller shall at no time own, occupy or control (or be deemed to control) any part of the Buyer's site(s) and/or hold or be fixed with any duties or liabilities under health and safety laws or regulations or common law in relation to any part of the Buyer's site(s).

## GENERAL

### 15. Payment and Other Buyer Obligations

(a) In respect of the Goods, subject to Condition 15(d) the Seller shall invoice the Buyer for the full purchase price of the Goods on or at any time after the despatch of the Goods.

(b) In respect of the Services, the Seller shall invoice the Buyer for the Services either monthly or quarterly as set out in the Contract.

(c) In the event that the Buyer chooses to purchase additional Goods or Services from the Seller that are not set out in the Contract but which are related to the Contract, the terms of such Contract will be deemed to apply to such additional Goods or Services and the Seller will invoice the Buyer for such Goods and Services pursuant to Condition 15(a) or 15(b), as appropriate, under the original Purchase Order number unless otherwise agreed between the parties.

(d) The Seller may in its absolute discretion agree in writing to the Buyer paying for the Goods in instalments, or may agree in writing to extend credit to the Buyer in respect of the payment for Goods. In the event that the Seller agrees to payment by instalments or extends credit in respect of the payment by the Buyer for Goods, the Seller shall invoice the Buyer monthly for agreed instalments of the purchase price. The Seller may in its absolute discretion by notice in writing to the Buyer withdraw (with immediate effect) the Buyer's right to credit or to pay for the Goods by instalments.

(e) The Buyer shall pay each invoice submitted by the Seller:

(i) within the earlier of thirty (30) days of the date of the invoice or such other period of time after the date of the invoice as has been agreed in the Contract; and

(ii) in Sterling or such other currency as the Seller may from time to time agree in writing) to a bank account nominated in writing by the Seller.

(f) Time is of the essence in relation to payment.

(g) All amounts payable by the Buyer under the Contract are exclusive of VAT chargeable from time to time. Where any taxable supply for VAT purposes is made under the Contract by the Seller to the Buyer, the Buyer shall, on receipt of a valid VAT invoice from the Seller, pay to the Seller such additional amounts in respect of VAT as are chargeable on the supply of the Services or the Goods at the same time as payment is due for the supply of the Services or the Goods.

(h) The Buyer shall make all payments due under the Contract in full without any deduction whether by way of set-off, counterclaim, discount, abatement or otherwise unless required by law.

(i) No payment shall be deemed to have been received until the Seller has received cleared funds.

(j) All payments payable to the Seller under the Contract shall become due immediately on its termination despite any other provision.

(k) If the Buyer fails to pay the Seller any sum due pursuant to the Contract by the due date for payment:

(i) the Buyer shall be liable to pay interest to the Seller at the maximum rate allowed by applicable law; and

(ii) the Seller may, in its absolute discretion and without liability to the Buyer, suspend performance of its obligations under the Contract and under any or all other Contracts between the Seller and the Buyer or terminate the Contract and any or all other Contracts between the Seller and the Buyer with immediate effect.

(l) If the Buyer pays any amount to the Seller without apportioning it between specific debts or liabilities, the amount paid shall be apportioned as the Seller thinks fit. The Seller may attribute the entirety of an amount paid to one or more specific items in respect of which payment is due, rather than to all the items in respect of which payment is due.

(m) Buyer shall comply with all applicable laws, statutes, regulations and codes from time to time in force, including those related to data protection and to anti-bribery and corruption. Buyer must comply with the requirements of the United Kingdom Bribery Act 2010 (the "Act") and shall not engage in any activity, practice or conduct which would constitute an offence under sections 1, 2, or 6 of the Act if such activity, practice or conduct had been carried out in the United Kingdom. Additionally, Buyer shall comply, and shall ensure compliance of any party with which it subcontracts complies, with the requirements of the United Kingdom Modern Slavery Act (2015), including ensuring that all forms of forced labour are eliminated from its business.

### 16. Cancellation

(a) No contract shall be cancelled by the Buyer except with the Seller's prior consent in

writing.

(b) In the event of the Seller agreeing to the Buyer cancelling all or any part of the Contract, the Seller may, without prejudice to any other rights against the Buyer which it may have, require the Buyer to pay a cancellation charge. Any cancellation charge will correspond to the type of contract being cancelled. Contracts for bespoke Goods manufactured by the Seller to the Buyer's specifications may be subject to a cancellation charge of 100% of the price of the Contract after the Order Acknowledgment has been sent.

(c) In the event that the Seller agrees to cancellation of a Contract in respect of the supply of Goods or Services (or both) which have been ordered to comply with the Buyer's special requirements, the Buyer shall be liable for all costs incurred by the Seller up to the time of cancellation of the Contract in addition to payment of a cancellation charge pursuant to Condition 16(b).

### 17. Intellectual Property

(a) The Buyer acknowledges that:

(i) the Intellectual Property Rights in the Goods and any materials prepared by the Seller or on its behalf which relate to the Goods and their development (including, without limitation, drawings, designs, samples, models and similar items) (the "Goods Materials") are the Property of the Seller or the third party manufacturers of the Goods (as applicable);

(ii) nothing in these Conditions or in a Contract shall be construed as conferring any licence or granting any rights in favour of the Buyer in the Intellectual Property Rights in the Goods or the Goods Materials. The Buyer may re-sell the Goods subject to the Seller's right to control the use of its trade marks within the European Economic Area or jurisdiction into which the Goods are sold and the Buyer shall assist the Seller as required in preventing parallel importers from diluting the Seller's rights; and

(iii) any goodwill in any trade marks affixed or applied to the Goods shall enure to the sole benefit of the Seller or any other owner of the trade marks from time to time.

(b) The Buyer shall not repackage the Goods and shall not without the Seller's prior consent in writing allow any trade marks of the Seller or other words or marks applied to the Goods to be obliterated, obscured or omitted or add any additional marks or words.

(c) The Buyer shall not use (other than pursuant to these Conditions or a Contract) or seek to register any trade mark or trade name (including any company name) which is identical to, confusingly similar to, or incorporates any trade mark or trade name which the Seller owns or claims rights in anywhere in the world.

(d) If at any time it is alleged that the Goods infringe the rights of any third party or if, in the Seller's reasonable opinion, such an allegation is likely to be made, the Seller may at its option and its own cost:

(i) modify or replace the Goods in order to avoid the infringement; or

(ii) procure for the Buyer the right to continue using the Goods; or

(iii) repurchase the Goods at the price paid by the Buyer, less depreciation at the rate the Seller applies to its own equipment.

(e) The Buyer shall promptly notify the Seller of:

(i) any actual, threatened or suspected infringement of any of the Intellectual Property Rights in the Goods or the Goods Materials (or both) which comes to the Buyer's notice; and

(ii) any claim by any third party that comes to the Buyer's notice that the sale or advertisement of the Goods or the use of the Goods Materials (or both) infringes the rights of any person.

(f) The Buyer agrees (at the Seller's request and expense) to do all such things as may be reasonably required to assist the Seller in taking or resisting any proceedings in relation to any infringement or claim referred to in Condition 17(e), and the Buyer shall not make any admissions or statements in respect of or compromise any such claim other than with the prior written consent of the Seller.

(g) In the event of any claim, proceeding or suit by a third party against the Buyer alleging an infringement of such party's rights by any of the Intellectual Property Rights in the Goods or the Goods Materials (or both), the Seller shall defend the claim, proceeding or suit at the Seller's expense, subject to:

(i) the Buyer promptly notifying the Seller in writing of any such claim, proceeding or suit; and

(ii) the Seller being given sole control of the defence of the claim, proceeding or suit, and provided that the Seller shall not be liable and shall not defend the claim, proceeding or suit to the extent that such infringements arise out of or in connection with modifications to the Goods or the Goods Materials (or both) made by anyone except the Seller or its authorised representative, or out of use or annexation of the Goods or the Goods Materials (or both) with or to products or third party materials not specified or expressly approved in advance in writing by the Seller, or where the claim, proceeding or suit arises from the Seller's adherence to the Buyer's requested changes to the Specification for Goods or from infringing items of the Buyer's origin, design or selection.

(h) The Seller shall reimburse the Buyer with an amount equal to any liability assessed against the Buyer by final judgment on account of an infringement described in Condition 17 (g).

# CONDITIONS OF SALE CONTINUED

(i) All Intellectual Property Rights in the or arising out of the or in connection with the Services shall be owned by the Seller.

(j) All Intellectual Property Rights in the materials, equipment, documents and other property of the Seller are the exclusive property of the Seller or of its licensors and shall be returned to the Seller on demand.

## 18. Trade Prohibitions

(a) The Buyer undertakes to the Seller that the Buyer shall not re-sell or otherwise supply the Goods to a third party which is the subject of any statutory trade prohibition of the United States of America or a member state of the European Union ("Sanctioned Third Party").

(b) Without prejudice to Condition 18(a), if the Seller shall have notice of or reasonable grounds to believe that the Buyer intends to re-sell or otherwise supply the Goods to a Sanctioned Third Party the Seller may upon giving notice thereof to the Buyer refuse to deliver the whole or any part of the Goods and shall have no liability to the Buyer for such refusal.

## 19. Limitation and Exclusion of Liabilities

(a) **SUBJECT TO AND WITHOUT LIMITING CONDITION 19(B) OR ANY OTHER CONDITION, THE SELLER SHALL NOT BE LIABLE TO THE BUYER WHETHER IN CONTRACT, TORT (INCLUDING NEGLIGENCE), BREACH OF STATUTORY DUTY, OR OTHERWISE, FOR ANY LOSSES (AS DEFINED) ARISING DIRECTLY OR INDIRECTLY OUT OF OR IN CONNECTION WITH ANY CONTRACT FOR THE SUPPLY OF GOODS AND/OR SERVICES (OR THAT PART OF A CONTRACT WHICH RELATES TO GOODS AND/OR SERVICES).**

(b) Notwithstanding any other terms of these Conditions the Seller does not limit or exclude its liability for fraud or fraudulent misrepresentation or for death or personal injury resulting from its negligence or the negligence of its employees, agents or subcontractors.

(c) **SUBJECT TO AND WITHOUT LIMITING CONDITION 19(B) OR ANY OTHER CONDITION, THE SELLER'S TOTAL LIABILITY TO THE BUYER IN RESPECT OF ALL OTHER LOSS ARISING OUT OF OR IN CONNECTION WITH ANY CONTRACT FOR THE SUPPLY OF GOODS AND/OR SERVICES (OR THAT PART OF A CONTRACT WHICH RELATES TO GOODS AND/OR SERVICES), WHETHER IN CONTRACT, TORT (INCLUDING NEGLIGENCE), BREACH OF STATUTORY DUTY, OR OTHERWISE, SHALL IN NO CIRCUMSTANCES EXCEED THE VALUE OF THE CONTRACT WHICH GAVE RISE TO BUYER'S CLAIM.**

(d) **THE BUYER ACKNOWLEDGES AND AGREES THAT THE LIMITED WARRANTIES AND ALL LIMITATIONS AND EXCLUSIONS OF THE SELLER'S LIABILITY SET OUT IN THESE CONDITIONS ARE REASONABLE AND ARE REFLECTED IN THE PRICE OF THE GOODS OR SERVICES (OR BOTH) (AS APPLICABLE) AND THE BUYER SHALL ACCEPT RISK OR INSURE ACCORDINGLY (OR BOTH).**

The Seller shall have no responsibility for any Losses incurred by the Buyer in the event that any information in any quotation or Order Acknowledgement is applied in connection with products other than the Goods and Services.

(f) This Condition 19 shall survive the termination or cancellation of the Contract.

## 20. Force Majeure

(a) The Seller shall not be liable to the Buyer as a result of any delay or failure to perform its obligations under the Contract as a result of a Force Majeure Event.

(b) If the Force Majeure Event prevents the Seller from providing any of the Services or Goods (or both) for more than forty-four (44) Business Days, the Seller shall, without limiting its other rights or remedies, have the right to terminate the Contract with the Buyer immediately by giving notice in writing to the Buyer.

## 21. Events of Default, Termination, Repossession, Suspension; Dispute Resolution

(a) The Seller may terminate the Contract with immediate effect by giving notice in writing to the Buyer if:

(i) the Buyer fails to pay any amounts due under the Contract on the due date for payment; or

(ii) the Buyer otherwise breaches the Contract with the Seller and the breach, if remediable and previously notified in writing to the Buyer, is not remedied within five (5) Business Days of the Buyer receiving such notice; or

(iii) the Seller terminates any other Contract between the Seller and the Buyer; or

(iv) the Buyer is or otherwise becomes insolvent or unable to pay its debts or suspends payment of its debts or threatens to do so or is unable to pay its debts as they fall due or admits its inability to pay its debts; or

(v) the Buyer commences negotiations with all or any class of its creditors with a view to scheduling any of its debts, or makes a proposal for or enters into any compromise or arrangement with its creditors other than for the sole purpose of a scheme for a solvent amalgamation;

(vi) a petition is filed, a notice is given, a resolution is passed, or an order is made, for or in connection with the winding up of the Buyer other than for the sole purpose of a scheme for a solvent amalgamation;

(vii) a creditor or encumbrancer of the Buyer attaches or takes possession of, or a distress, execution, sequestration or other such process is levied or enforced on or

sued against, the whole or any part of its assets and such attachment or process is not discharged within fourteen (14) days;

(viii) an application is made to court, or an order is made, for the appointment of an administrator or if a notice of intention to appoint an administrator is given or if an administrator is appointed over the Buyer;

(ix) the holder of a qualifying charge over the assets of the Buyer has become entitled to appoint or has appointed an administrative receiver;

(x) a person becomes entitled to appoint a receiver over the assets of the Buyer or a receiver is appointed over the assets of the Buyer;

(xi) any event occurs, or proceeding is taken, with respect to the Buyer in any jurisdiction to which it is subject that has an effect equivalent or similar to any of the events mentioned in Conditions 21(a)(iv) to Condition 21(a)(x) (inclusive);

(xii) the Buyer suspends, threatens to suspend, ceases or threatens to cease to carry on, all or substantially the whole of its business;

(xiii) the Buyer's financial position deteriorates to such an extent that in the Seller's opinion the Buyer's capability to adequately fulfil its obligations under the Contract has been placed in jeopardy.

(b) In the event that the Seller terminates the Contract pursuant to Condition 21(a) the Seller may (in its absolute discretion and without prejudice to its other rights under these Conditions or otherwise) by notice in writing to the Buyer do any one or (to the extent not inconsistent with one another) more of the following:

(i) suspend any deliveries of Goods to be made under any contract with the Buyer;

(ii) revoke any express or implied authority to sell or use any Goods the title in which has not passed to the Buyer ("Relevant Goods");

(iii) require the Buyer to deliver to the Seller any Relevant Goods; and the Buyer shall do so, failing which the Seller may enter the premises where the Relevant Goods are or are thought to be and repossess the Goods, without liability for any resulting damage to the Buyer's premises, plant or equipment.

(c) All disputes arising out of or in connection with the Contract shall be submitted to the International Court of Arbitration of the International Chamber of Commerce and shall be finally settled under the Rules of Arbitration of the International Chamber of Commerce by one or more arbitrators appointed in accordance with the said Rules. The place of arbitration shall be London with the laws of England governing the Contract. The language of the arbitration shall be English.

## 22. Confidentiality

Each of the Seller and the Buyer (the "Receiving Party") shall keep in strict confidence all technical or commercial know-how, specifications, inventions, processes or initiatives which are of a confidential nature and have been disclosed to the Receiving Party by the other party ("Disclosing Party"), its employees, agents or subcontractors, and any other confidential information concerning the Disclosing Party's business, its products and services which the Receiving Party may obtain. The Receiving Party shall only disclose such confidential information to those of its employees, agents and subcontractors who need to know it for the purpose of discharging the Receiving Party's obligations under the Contract, and shall ensure

that such employees, agents and subcontractors comply with the obligations set out in this Condition 22 as though they were a party to the Contract. The Receiving Party may also disclose such of the Disclosing Party's confidential information as is required to be disclosed by law, any governmental or regulatory authority or by a court of competent jurisdiction. This Condition 22 shall survive termination or cancellation of the Contract.

## 23. Miscellaneous

(a) The Seller's rights under these Conditions are in addition to any other rights which the Seller may have under the general law or otherwise.

(b) If the Buyer comprises two or more persons, their obligations are joint and several.

(c) The Buyer shall not assign, transfer, mortgage, charge, sub-contract, or otherwise dispose of or deal in any Contract or any rights or obligations (or both) (as applicable) thereunder in whole or in part without the Seller's prior consent in writing. Any such action purported to be taken by the Buyer without the Seller's prior consent in writing shall be void.

(d) The Seller may at any time assign, transfer, mortgage, charge, sub-contract or otherwise dispose of or deal in its rights or obligations (or both) (as applicable) under any Contract or any part of it to any person, firm or company.

(e) A waiver by the Seller of any right under the Contract or law will only be effective if it is in writing. Any failure or delay by the Seller in exercising, or any partial exercise by the Seller, of any right or remedy under the Contract or by law shall not constitute as a waiver of that or any other right or remedy. No single exercise by the Seller shall prevent the further exercise of that or any other right or remedy.

(f) Any waiver by the Seller of any breach of, or any default under, any provision of the Contract by the Buyer shall not be deemed a waiver of any subsequent breach or default and shall no way affect the other terms of the Contract.

(g) No term of the Contract shall be enforceable by any person that is not a party to it.

(h) This Condition 23 shall survive termination or cancellation of the Contract.

# CONDITIONS OF SALE CONTINUED

## 24. Notices

(a) Any notice to be given by the Buyer under these Conditions or any relevant Contract to the Seller shall be in writing and given by prepaid first class post or hand-delivered to Aflex Hose Limited, Bradley Business Park, Huddersfield, West Yorkshire, HD2 1GZ or to such other address or for the attention of such person as the Seller may notify to the Buyer.

(b) Any notice to be given by the Seller under these Conditions or any relevant Contract to the Buyer shall be in writing and given by prepaid first class post or hand-delivered to any address from which the Seller has received communications from the Buyer in connection with these Conditions or the Contract.

(c) Notices shall be deemed to have been received:

- (i) if sent by prepaid first class post, two (2) Business Days after posting (exclusive of the day of posting); or
- (ii) if delivered by hand, on the day of delivery.



BIOFLEX ULTRA  
CORROFLON  
CORROLINE+  
PHARMALINE N&X  
SMOOTHBORE  
HYPERLINE FX  
VISIFLON

**UK**

Dyson Wood Way  
Bradley Business Park  
Huddersfield  
West Yorkshire, HD2 1GZ

Tel: +44 (0) 1422 317200

**USA**

32 Appletree Lane  
Pipersville  
Bucks County  
Pa 18947

Tel: 215 - 766 - 1455  
Fax: 215 - 766 - 1688



[WWW.AFLEX-HOSE.COM](http://WWW.AFLEX-HOSE.COM)

**AFLEX HOSE**  
The world's leading manufacturer of  
PTFE Flexible Hose