

Visiflon (Hyperline V)

CONVOLUTED PTFE LINED FLEXIBLE HOSE



- VERY FLEXIBLE
- CHEMICAL RESISTANT
- TEMPERATURE RESISTANT

CONTENTS

Front Cover	Page 1
Contents	Page 2
PTFE - The Optimum Choice For Visiflon Hose Linings	Page 3
Visiflon (Hyperline V) Hose and Hose Grades	Page 4
Visiflon Hose Specifications and Properties	Page 5
Visiflon Hose Supply Options, Loose Hose & Assemblies	Page 6
Visiflon Hose Assembly Instructions	Page 7
Visiflon Hose - Quality Assurance Certificates and Approvals	Page 8
Correct Hose Configuration	Pages 9 - 11
Conditions of Sale	Page 12
Back Cover	Page 13

PTFE - THE OPTIMUM CHOICE FOR VISIFLON HOSE LININGS



Section from a PTFE Molecule,
16 Angstrom Units long.

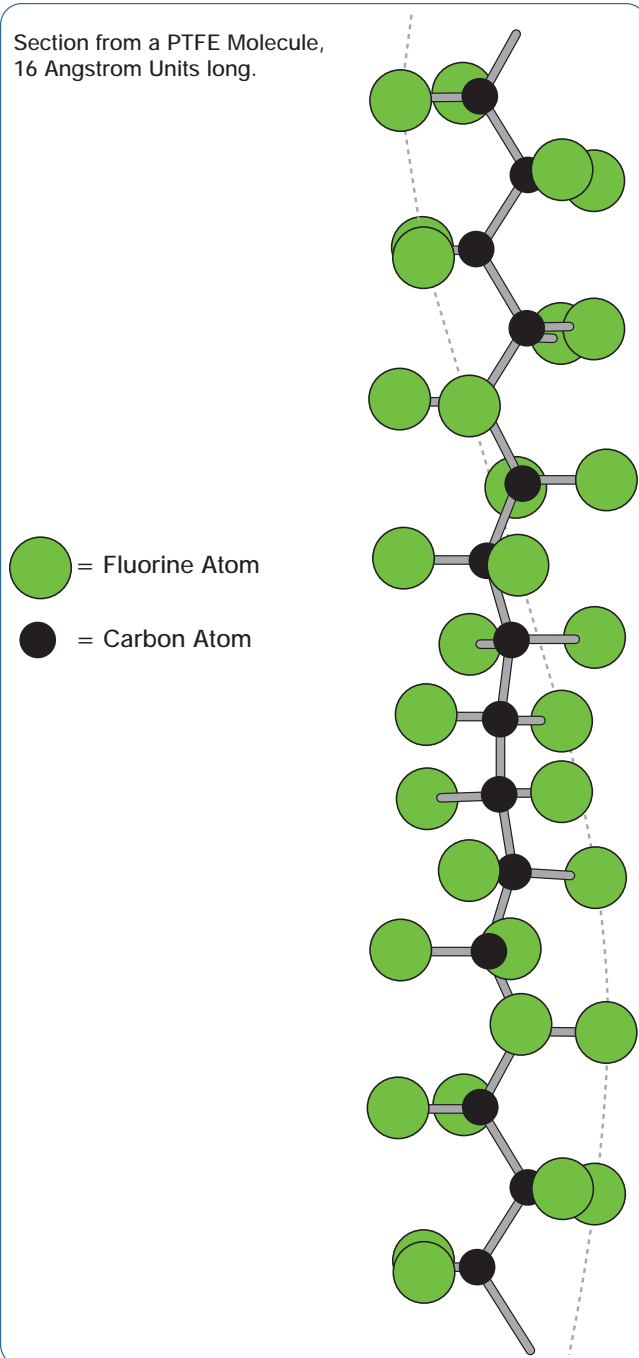

PTFE, or Polytetrafluoroethylene, comprises long-chain molecules of carbon atoms, each linked to two fluorine atoms.

The fluorine atoms provide a helical spiral which surrounds the carbon chain and protects it.

It is this structure which creates the unique properties for which PTFE is well-known.

Excellent Chemical Resistance

PTFE is renowned as the most chemically resistant material known. Only a very few, very unusual substances and conditions can affect it, like Fluorine gas at high temperature and pressure and liquid, boiling sodium metal.

PTFE lined hoses can therefore be used for a wider variety of chemicals than any other hose type, making it the ideal choice for very corrosive chemical applications and multi-product applications.

Non-Stick Surface

The use of PTFE as a surface for cookware products has demonstrated to the world how easily cleanable PTFE surfaces are.

This means that PTFE lined hoses can be purged 100% clean more quickly, easily and reliably than any other type of hose.

Excellent Temperature Range

The cookware application also demonstrates another of PTFE's many attributes - temperature resistance. PTFE itself can be used as a hose liner at temperatures from -150°C up to $+260^{\circ}\text{C}$, dependent upon the hose design and the application conditions.

This is the widest temperature range of any rubber or plastic hose lining material.

Hose Design

The only issue with PTFE as a hose lining material is the best way it can be integrated in to the hose design. This is where Aflex Hose have a proven record of success over the last 30 years.

VISIFLON (HYPERLINE V) HOSE AND HOSE GRADES

Visiflon was previously named Hyperline V - either name applies, but Visiflon is now the conventional name applied.

Visiflon includes a helically convoluted PTFE liner tube, and the tube is fully convoluted inside and out. (This is different to Hyperline FX tube, which is only convoluted on the outer surface).

This convoluted liner design makes the hose very flexible and very kink resistant across the size range.

Visiflon Hose Assembly with a Fixed Male End Fitting crimped on to the hose



STANDARD GRADES AVAILABLE

- Visiflon GP, TO** - Natural PTFE Tube Only, No Braid.
- Visiflon GP, AS, TO** - Antistatic Black PTFE Tube Only, No Braid.

- Visiflon GP, SS** - Natural PTFE Tube external AISI 304 Stainless Steel Wire Braid.
- Visiflon GP, AS, SS** - Antistatic Black PTFE Tube, external AISI 304 Stainless Steel Wire Braid.

- *Visiflon GP, PB** - Natural PTFE Tube, Orange Polypropylene Yarn Braid.
- *Visiflon GP, AS, PB** - Antistatic Black PTFE Tube, Orange Polypropylene Yarn Braid.

GRADE DESCRIPTIONS

Antistatic PTFE Linings (AS Grade)

When electrically resistive fluids like solvents and fuels, or multiphase mixtures are passed through natural PTFE hose at high flow rates, a static charge build up occurs on the inner wall of the PTFE liner, which eventually discharges to the nearest earth creating a leak path through the liner.

Antistatic PTFE includes a small quantity of a special carbon black which ensures safe static charge dissipation, in accordance with International Standards.

Stainless Steel Wire Braid (SS Grades)

The braid protects the PTFE liner tube against internal pressure and mechanical abuse.

Polypropylene Yarn Braid (PB Grades)

The braid is lighter in weight than SS braid, and any ends broken in service will not cut an operator's hands.

Operating Temperatures & Pressures, however are limited.

***Note:** PB Grades are usually only available to Special Order.

VISIFLON HOSE : SPECIFICATIONS & PROPERTIES



SPECIFICATIONS FOR VISIFLON HOSE GRADES

Note: Specifications listed below are for non-AS Grades. For AS Grades the specifications are all the same, except that "AS" is added to the Grade Reference, and the Part Number reads "-110-" in place of "-100-".

Nominal Hose Size	*Actual Hose Bore Size		Hose Grade	Outside Diameter of Tube or Braid		Minimum Bend Radius		Maximum Working Pressure (MWP)		Weight per Unit Length		Hose Part Number
	in	mm		in	mm	in	mm	in	Bar	psi	Kg/mtr	
3/8	6.3	1/4	TO	10.70	0.420	25	1	4	58	.057	.038	71-100-06
			SS	11.95	0.470	19	3/4	60	870	.144	.096	71-100-06-01-02
			PB	13.00	0.512	25	1	30	435	.091	.061	71-100-06-01-21
1/2	9.5	3/8	TO	14.10	0.555	38	1 1/2	4	58	.076	.051	71-100-08
			SS	15.25	0.600	25	1	47	680	.195	.130	71-100-08-01-02
			PB	16.80	0.662	38	1 1/2	23.5	340	.125	.084	71-100-08-01-21
5/8	12.7	1/2	TO	19.80	0.780	50	2	4	58	.126	.084	71-100-10
			SS	21.20	0.835	38	1 1/2	40	580	.296	.194	71-100-10-01-02
			PB	23.00	0.906	50	2	20	290	.188	.126	71-100-10-01-21
3/4	16.0	5/8	TO	21.20	0.835	75	3	3	43	.166	.111	71-100-12
			SS	22.70	0.894	50	2	32	460	.376	.251	71-100-12-01-02
			PB	24.70	0.973	63	2 1/2	16	230	.226	.151	71-100-12-01-21
1	22.0	7/8	TO	29.00	1.143	89	3 1/2	3	43	.235	.157	71-100-16
			SS	30.60	1.204	63	2 1/2	26	380	.533	.310	71-100-16-01-02
			PB	32.90	1.300	75	3	13	190	.314	.210	71-100-16-01-21
1 1/4	28.0	1 1/8	TO	34.20	1.349	100	4	2	29	.342	.229	71-100-20
			SS	36.00	1.420	75	3	25	360	.729	.489	71-100-20-01-02
			PB	39.00	1.537	89	3 1/2	12.5	180	.444	.298	71-100-20-01-21
1 1/2	35.0	1 3/8	TO	45.00	1.773	150	6	2	29	.415	.278	71-100-24
			SS	47.00	1.850	115	4 1/2	20	300	1.044	.699	71-100-24-01-02
			PB	50.00	1.970	130	5	10	150	.600	.402	71-100-24-01-21
2	47.0	1 7/8	TO	59.00	2.325	200	8	2	29	.631	.423	71-100-32
			SS	61.00	2.400	130	5	15	220	1.378	.923	71-100-32-01-02
			PB	64.00	2.521	150	6	7.5	110	.917	.614	71-100-32-01-21

*Visiflon Hose assemblies require that the convolutions at the ends of the hose are opened out to accept either Hydraulic or PTFE Tail end fittings (see page 7).

Note: Many of the sizes of hose and fittings listed in this brochure are available as ex-stock items and are priced accordingly. However, some of the less popular items are not always in stock, and may therefore incur a minimum order charge or a set-up charge for smaller quantities. Aflex Hose will advise when the enquiry is made.

PROPERTIES

Temperatures and Pressures :

- **Visiflon TO Grades** - The MWP listed above applies up to a maximum temperature of 100°C (212°F).
- **Visiflon SS Grades** - The MWP listed above should be reduced by 1% for each 1°C above 130°C up to a maximum of 230°C (1% for each 1.8°F above 266°F up to a maximum of 445°F).
- **Visiflon PB Grades** - The MWP listed should be reduced by 5% for each 1°C above 80°C up to a maximum of 100°C (5% for each 1.8°F above 176°F to 212°F).

Vacuum Resistance :

Visiflon SS Grades are fully vacuum resistant up to 130°C (266°F).

Visiflon TO and PB Grades are fully vacuum resistant up to 80°C (176°F).

Flow Rates :

The internal convolutions restrict flow rates due to turbulent flow, and may also cause a whistling noise when gases are passed through. For any applications where this may be a problem, the alternative Aflex Hose products Hyperline FX or Corroline would provide a solution.

VISIFLON HOSE - SUPPLY OPTIONS, LOOSE HOSE & ASSEMBLIES

SUPPLY OPTIONS :

Visiflon hose can either be supplied as made up and crimped hose assemblies, or as loose hose for customers to assemble themselves, using ferrules supplied by Aflex Hose, and either standard hydraulic end fittings or PTFE Tail end fittings.

LOOSE HOSE : Visiflon hose can be supplied loose, in coils or on wooden reels if required, for Customers to assemble themselves.

For self-assembly, Customers must purchase not only the hose, but also the ferrules from Aflex Hose. If PTFE Tail design fittings are used, these must also be supplied by Aflex Hose, but Hydraulic Fittings are generally available.

Assembly must be carried out in accordance with the Instructions (page 7), and assemblers should be trained by Aflex Hose staff.

ASSEMBLIES :

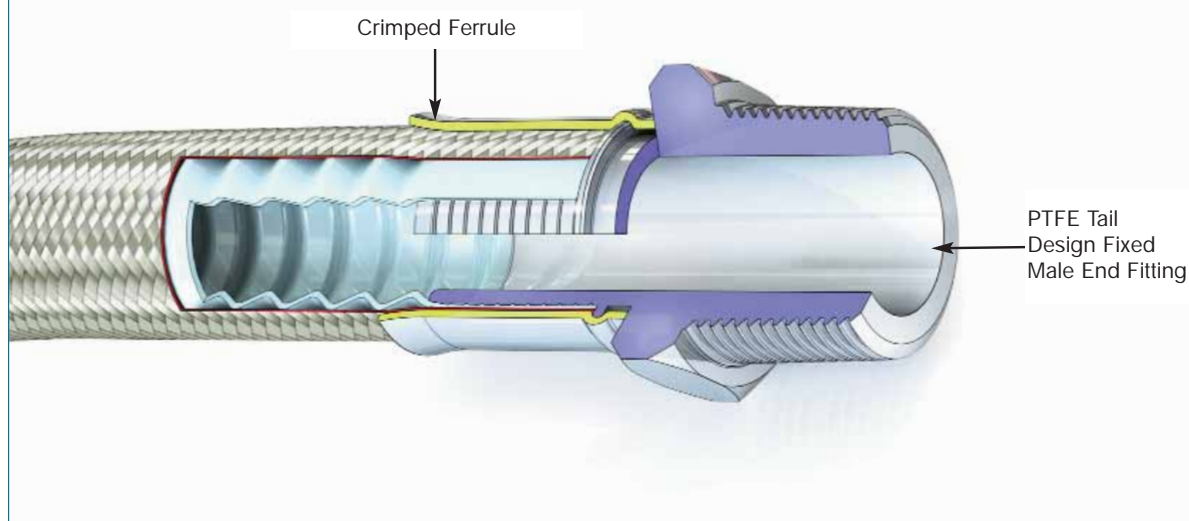

Aflex Hose can supply fully assembled Visiflon hose assemblies, with crimped ends.

A wide variety of End Fittings are available in Grade 316L Stainless Steel and Zinc Plated Mild Steel, including:

- 60° BSP Cone Seat Female Unions (also flat seat)
- Flat Seat Lug Nut Female Unions
- BSPT or NPT Fixed Males
- NPT Fixed Females
- 37° JIC Female Fittings
- 37° JIC/NPT Male Unions
- 37° JIC/NPT Female Unions
- Tube Fittings
- Standpipe Fittings

Note: stainless steel and carbon steel Hydraulic Tail end fittings and carbon steel PTFE Tail end fittings do not always have a fine machined surface through the bore, and so are not suitable for certain specialised or hygienic applications which require a smooth bore. In such applications, stainless steel PTFE Tail end fittings should be used.

VISIFLON HOSE ASSEMBLY INSTRUCTIONS



ASSEMBLY INSTRUCTIONS :

1. Cut the hose to the required length, preferably using a hose cut off machine with a hardened steel blade, allowing for the length of the end fitting.
2. Assemble the correct ferrules (see list) on to the hose ends.
3. Open the hose bore, by screwing in then pulling out the correct Visiflon Opening Tool (Manual or Motorised). For hydraulic fittings, use the basic tool. For PTFE tail fittings, add the correct collar to the tool.
4. Insert the end fitting, then push the ferrule fully over the hose up to the end fitting.
5. Crimp the ferrule to the correct diameter as given in Aflex Document AS-42 for Hydraulic Inserts, or AS-VI-01 for PTFE Tail Inserts. These are available on an I-Bay system - apply to Aflex Hose for access codes. Check using a Vernier or Micrometer.
6. Pressure test the assembly with air or water to 1.5 x listed Maximum Working Pressure before use in application.

Part Numbers for Visiflon Hose Ferrules (GP or GP, AS Grade Liner) :

Visiflon Hose Size & Grade	PTFE TAIL		HYDRAULIC TAIL	
	Mild Steel	Stainless Steel	Mild Steel	Stainless Steel
3/8" GP, SS	01-120-06-06-04	01-120-06-06-02	01-170-06-06-04	01-170-06-06-03
3/8" GP, PB	X	01-180-06-06-02	01-170-06-06-04	01-170-06-06-03
1/2" GP, SS	01-120-08-08-04	01-120-08-08-02	01-170-08-08-04	01-170-08-08-03
1/2" GP, PB	01-150-08-08-04	01-180-08-08-02	01-170-08-08-04	01-170-08-08-03
5/8" GP, SS	X	01-180-10-10-02	01-170-10-10-04	01-170-10-10-03
3/4" GP, SS	01-150-12-12-04	01-240-12-12-02	01-170-12-12-04	01-170-12-12-03
3/4" GP, PB	01-180-12-12-04	01-240-12-12-02	01-170-12-12-04	01-170-12-12-03
1" GP, SS	01-150-16-16-04	01-150-16-16-02	01-170-16-16-04	01-170-16-16-03
1" GP, PB	01-180-16-16-04	01-180-16-16-02	01-170-16-16-04	01-170-16-16-03
1 1/4" GP, SS	01-150-20-20-04	01-150-20-20-02	01-190-20-20-04	01-190-20-20-02
1 1/4" GP, PB	X	01-155-20-02-02	01-190-20-20-04	01-190-20-20-02
1 1/2" GP, SS	01-150-24-24-04	01-150-24-24-02	01-190-24-24-04	01-190-24-24-02
1 1/2" GP, PB	01-155-24-24-04	01-155-24-24-02	01-190-24-24-04	01-190-24-24-02
2" GP, SS	01-150-32-32-04	01-150-32-32-02	01-190-32-32-04	01-190-32-32-02
2" GP, PB	01-155-32-32-04	01-155-32-32-02	01-190-32-32-04	01-190-32-32-02

Note: **X** = This ferrule is not currently available.

VISIFLON HOSE : SPECIAL USAGE CONDITIONS

PTFE Hose-Use with Alkali Metals, Halogens and Halogen containing Chemicals

PTFE hose liners react chemically with Fluorine, Chlorine Trifluoride and molten Alkali Metals.

When PTFE lined hose is used to carry Chlorine or Bromine, either as gasses or fluids, they will diffuse into and through the PTFE liner wall thickness. Trace quantities will then combine with atmospheric moisture to corrode any braid/rubber outer coverings.

Heavily halogenated chemicals, like Hydrogen Fluoride, Hydrogen Chloride, Phosgene (Carbonyl Chloride) Carbon Tetrachloride and other organic chemicals with a high halogen content can also be absorbed and transmitted through the PTFE liner tube.

Other "Penetrating" Fluids and Gases

Sulphur Trioxide, Methyl Methacrylate, Caprolactam and Glacial Acetic Acid are some other chemicals which can be absorbed and transmitted through the PTFE liner tube wall.

Generally, however, as a hydrophobic (non-wetting) material, PTFE is very resistant to the absorption of chemicals. In some cases, PTFE has superior resistance to diffusion, for example to the diffusion of automotive fuels, in comparison with all other plastics and rubbers.

Gas/Fluid Cycling

There are some applications where the fluid passing through the hose turns into a gas, then back into a fluid, then into a gas etc, in a cyclic sequence.

This is normally associated with changes in temperature and/or pressure. For complex reasons these conditions are extremely damaging to the hose liner, whatever material it is made from.

For example, hoses are sometimes used to pass steam, water, steam etc into rubber moulding presses, in order to heat the mould, then rapidly cool it before reheating in the next cycle. Hoses of all types fail rapidly in such an application and PTFE lined hoses are no exception.

Please contact Aflex Hose for further information if these conditions apply.

Connecting Assemblies for Use in Applications

The lengths of hose assemblies and their configuration in use when connected into the application must always be in accordance with the Hose Configuration information at the end of this product literature.

When being connected for use in applications, the end fittings on hose assemblies must be connected to correct mating parts in the correct way, using the correct tools, spanners, clamps, nuts and bolts etc. The connections must be sufficiently tightened to ensure that the joint is leak free but not be over tightened as this can damage the sealing surfaces.

In applications involving the transfer through the hose of expensive or dangerous fluids or gases, the hoses and connections must be pressure tested in situ before being put in to service. This should be done with some harmless media to 1½ times the maximum working pressure of the hose assembly, as stated in the product literature.

If in doubt please contact Aflex Hose for advice.

Special Applications

Aflex Hose PTFE lined hose products are not rated as suitable for use in the following, special applications:

All Radioactive Applications involving high energy radiation, including Gamma radiation (degrades PTFE)

All Medical Implantation Applications.

All Aerospace Applications.

VISIFLON HOSE : QUALITY ASSURANCE CERTIFICATES AND APPROVALS

Visiflon Hose and Quality Assurance, Certification and Approvals

BS EN ISO 9001:2008

Aflex products are all manufactured in accordance with BS EN ISO 9001: 2008 Quality Management Systems independently assessed and registered by National Quality Assurance Limited (NQA).

FDA

The Materials used to manufacture the natural PTFE Tube liner conforms to FDA 21 CFR 177.1550, and the antistatic PTFE liner conforms to FDA 21 CFR 178.3297.

3-A Sanitary Standards

The PTFE used in the liner is manufactured solely from materials which meet the requirements of the 3-A Sanitary Standards.

Automotive Fuel Hose - SAE J1737

Tested and approved for automotive fuel hose use in accordance with SAE J1737.

CE Marking (Europe only)

Aflex has been assessed by Zurich Engineering and found to comply with the Pressure Equipment Directive 97/23/EC (European Community) Conformity Assessment Module D1, approved to CE Mark applicable hose products, accompanied by a Hose Usage Data Sheet, and a Declaration of Conformity.

Attestations of Conformity to ATEX Directive 94/9/EC (Potentially Explosive Atmospheres)

Available for hose and assemblies for components used in Gas Zones 1 & 2 and Dust Zones 21 & 22, when applicable.

Material Certification to EN10204

Available for all the hose or hose assembly components.

Certificates of Conformity to BS EN ISO/IEC 17050

Are available for all products.

HOSE CONFIGURATION & LENGTH CALCULATIONS

- for BEND RADIUS

Hose Configuration Requirements

Hose Assemblies are usually connected at both ends in service. They may then either remain in a fixed, or static configuration or in a flexing, or dynamic configuration.

Whether static or dynamic, the First Rule concerning the configuration of the hose is that the bend radius of the hose must never be less than the Minimum Bend Radius (MBR) for the hose as listed in the relevant hose brochure.

The most common situation when this is likely to occur is when the hose is flexed at the end fitting, with stress being applied to the hose at an angle to the axis of the end fitting. Typically, this happens either because the length of the hose is too short, or because the weight of the hose plus contents creates a stress at an angle to the end fitting.

The Second Rule, therefore, if possible, is to design the configuration to ensure that any flexing in the hose takes place away from the end fittings.

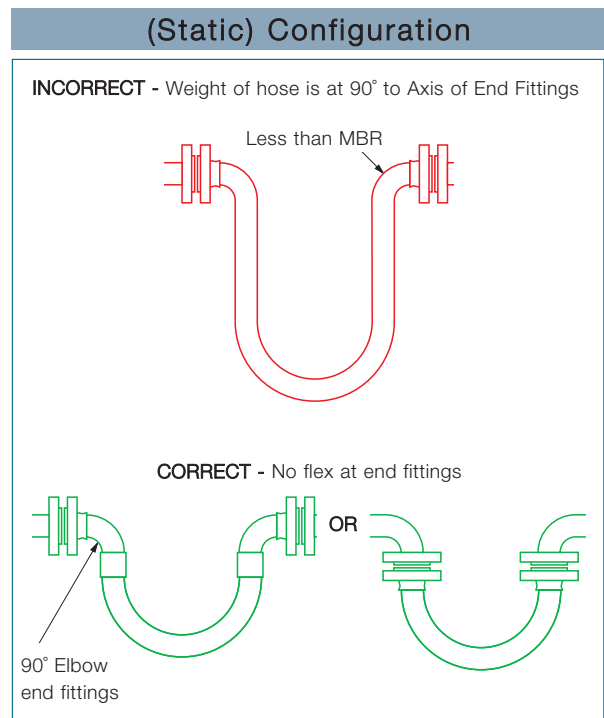
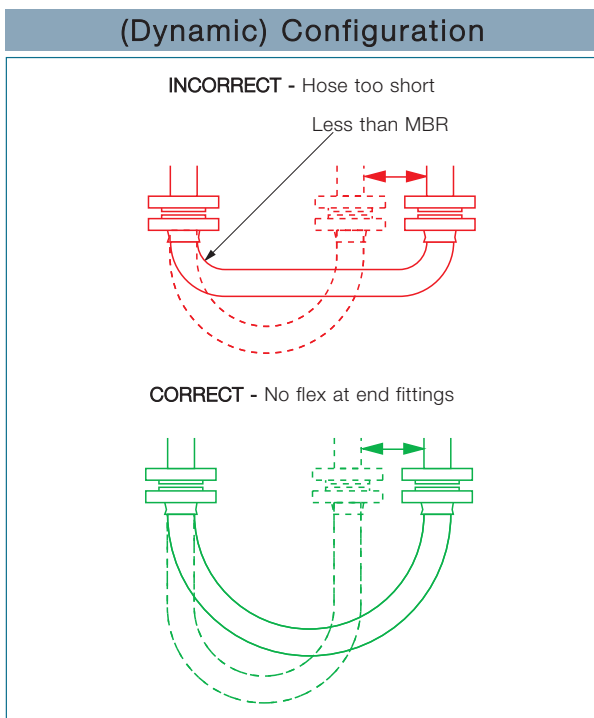

HOSE CONFIGURATION & LENGTH CALCULATIONS

- for ABRASION & TORQUE



The Third Rule is that the hose configuration should always be designed, and supported where necessary, to avoid any possibility of external abrasion.

In some cases, the length, configuration and angle of the hose can be designed to avoid abrasion. In others, static or moving support frames or support wheels are required.

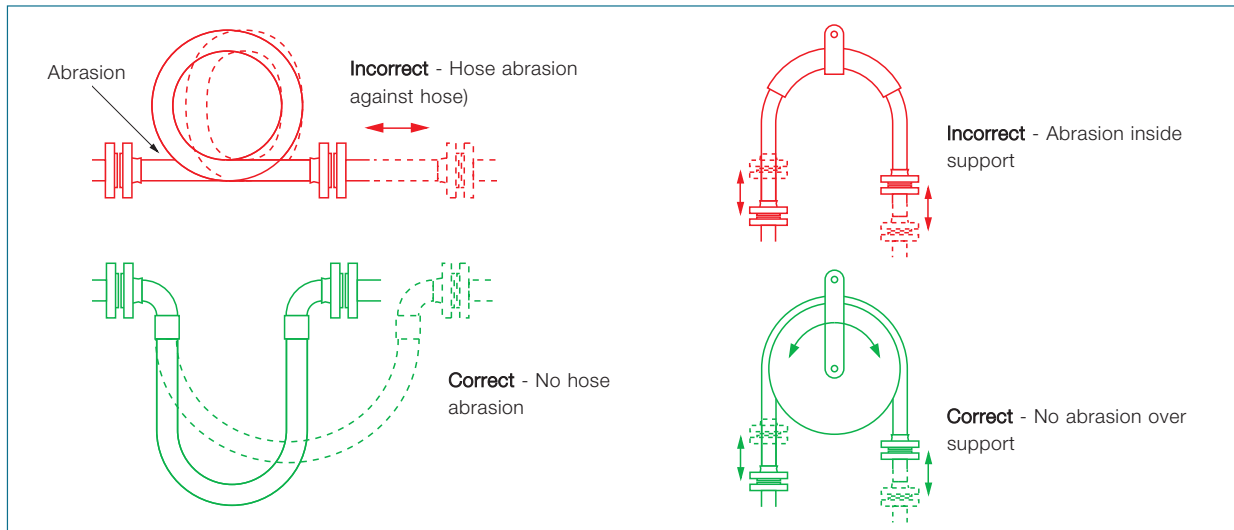

The Fourth Rule is that the hose must not be subjected to torque, either during connection, or as a result of the flexing cycle.

Torque (twist) in the hose can be applied during connection if the hose is accidentally twisted, or if the second end being connected is a screwed connection, and the hose is subjected to torque during final tightening.

In a flexing application, if any flexing cycle of the hose occurs in 3 dimensions instead of 2, then torque will also occur:

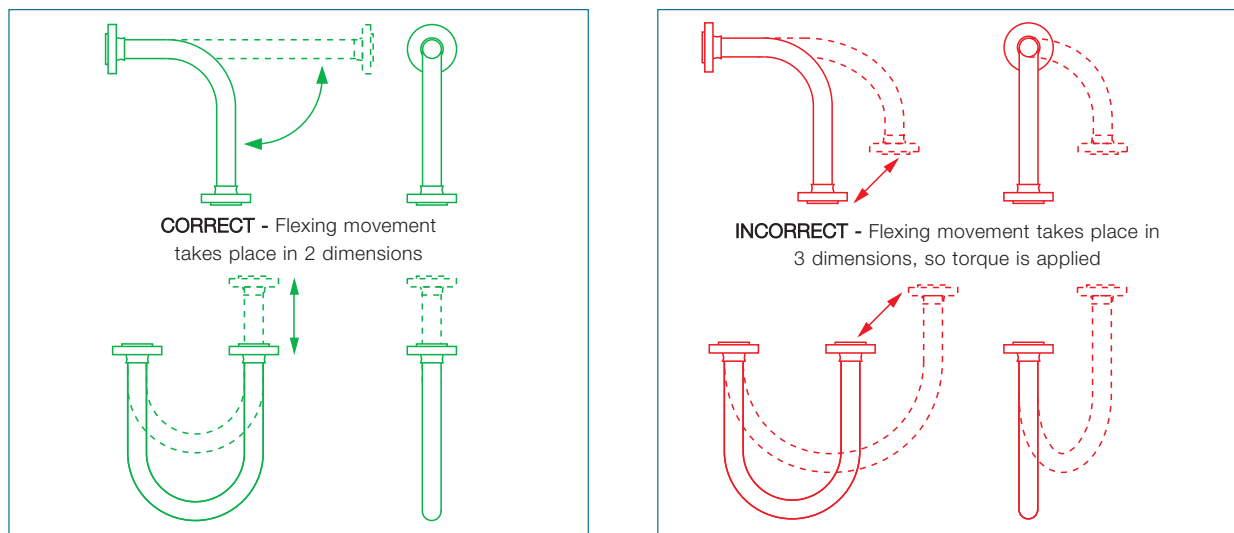

Both Pharmaline and Pharmalex hose have good resistance to a small level of torque, much better resistance than rubber or SS hose types, but it is still the best practice to take whatever steps are necessary to eliminate torque. If in doubt, consult Aflex Hose.

HOSE CONFIGURATION & LENGTH CALCULATIONS

- for LENGTH CALCULATIONS

CALCULATING THE HOSE LENGTH

The formula for calculating the bent section of the hose length around a radius is derived from the basic formula that the circumference of a circle = $2\pi R$, where R = the radius of the circle, and π = a constant, = 3.142.

So, if the hose goes around a 90° bend, which is $\frac{1}{4}$ of a full circumference, and the radius of the bend is R , then the length of the hose around the bend is = $\frac{1}{4} \times 2\pi R$. Or half way round, in a U-shape, = $\frac{1}{2} \times 2\pi R$.

Note :

In calculating the length of a hose assembly, the (non-flexible) length of the end fittings must be added in, also the length of any straight sections of hose, as in the following example:

Example :

To calculate the length for a 2" bore size hose with flange end fittings, to be fitted in a 90° configuration with one leg 400mm long, the other 600mm long.

$$\begin{aligned} \text{Length of Bent Section (yellow)} &= \frac{1}{4} \times 2\pi R \text{ (334)} \\ &= \frac{1}{4} \times 2 \times 3.142 \times 334 = \mathbf{525\text{mm}} \end{aligned}$$

$$\begin{aligned} \text{Length of top, Straight Section, including the top end fitting length} \\ &= 600 - 334 = \mathbf{266\text{mm}} \end{aligned}$$

$$\text{Length of bottom end fitting} = \mathbf{66\text{mm}}$$

$$\text{Total length of Hose Assembly} = 525 + 266 + 66 = \mathbf{857\text{mm}}$$

Things to consider

- A hose will normally take the longest radius available to it to go around a corner, not the MBR! Also - always remember to include the **non-flexible** end fitting lengths.
- In dynamic applications, remember to always calculate the lengths for the most extended configuration during the flexing cycle, not the least extended.
- If the configuration is simply too complex for calculation, then obtain a length of flexible tubing of some kind, mark on paper, or a wall, or floor, or both where the connection points will be relative to each other, scaled down if necessary, then manually run the flexible tubing between them with full radii round bends. Measure the extended length, then scale up if necessary to determine the approximate length of the hose.

If in doubt, consult Aflex Hose.

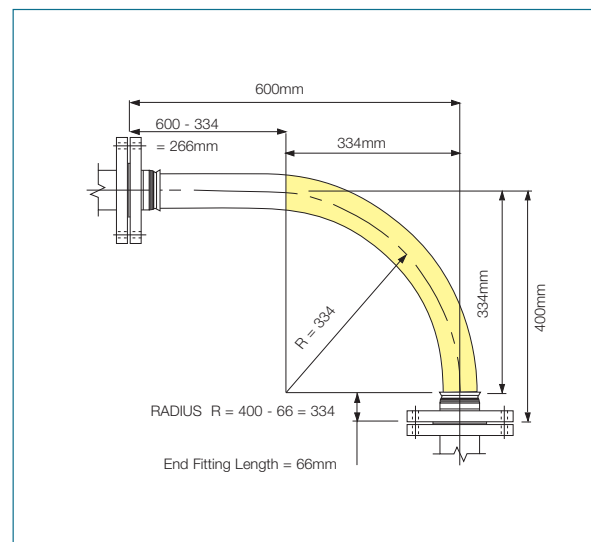
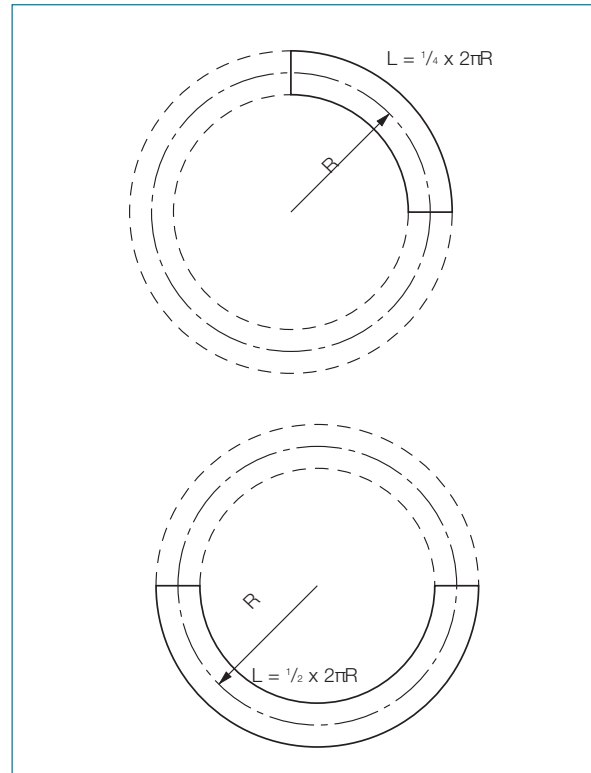

CONDITIONS OF SALE

General

(1) Aflex Hose Products have not been designed or tested for use in **Aerospace, Medical Implantation or Radioactive applications**, and such use is therefore strictly prohibited unless written approval from Aflex Hose Ltd has been given.

(2) Aflex Hose Ltd will not accept liability for any failures of the Aflex Hose Products which are caused by Customers failing to perform their Responsibilities as specified in these Conditions of Sale.

(3) It is the Customer's strict Responsibility to review all of the usage limitations given for the Aflex Hose Product which is intended for use in a particular application, to ensure that the application conditions are in compliance with those usage limitations. The usage limitations are specified both on this page and in the relevant Full Product Brochure on the Aflex Hose website. Customers must always consult the latest, up to date hose product information at the time of ordering, which is only available and downloadable from the Aflex Hose website, or on request from Aflex Hose Ltd.

(4) If a Customer sells or passes on any Aflex Hose Products to others, then it is the Customer's Responsibility to ensure that the final end user of the Aflex Hose Product is supplied with this document and the Aflex Hose website address, together with notification of the requirement to review the usage limitations.

(5) The Customer must accept, however, that the usage limitations specified elsewhere in the Hose Product Information on the Aflex Hose Website and on this page are intended as a guide only, since every possible factor in every type of application cannot possibly be anticipated and fully covered. It is therefore the Customer's Responsibility to ensure the design suitability and safety of the Aflex Hose Products in their intended applications, giving particular consideration to the chemical and electrostatic compatibility of the fluids or gases passing through, the possibility of diffusion of fluid or gases through the PTFE hose lining, the possibility of external corrosive conditions, the types and likelihood of excessive mechanical abuse, such as abrasion (internal or external), crushing, excessive flexing or vibrations etc, and any excessive temperature and/or pressure "pulsing" conditions, or any other condition, which may cause premature hose failure. It is also the Customer's Responsibility to consider, and take account of the degree of risk involved in any hose failure, including the provision of adequate protection in the event of any risk to employees or the general public. In applications where any type of hose failure would lead to financial losses if the hose is not replaced immediately, it is the Customer's Responsibility to order and hold in stock spare hose(s) accordingly. It is also the Customer's Responsibility to advise Aflex Hose in writing at the time of placing the enquiry and on any purchase order if there are any special requirements for the hose, including special cleaning, or drying, or extra testing requirements which are in addition to normal industrial standards.

(6) If the Customer has any doubts concerning these or any other usage limitation or safety parameters, it is the Customer's Responsibility to consult Aflex Hose Ltd and to request a written response to any queries.

Hose Service Life

(7) It is not possible to guarantee a minimum service life for any of the Aflex Hose Products which can be applicable for every type of application.

(For example, Aflex PTFE lined hose has been used in one application where it was cycled with hot steam, then cold water, also flexed every 17 seconds 24 hours per day, and the customer was very satisfied with a service life of 3 weeks before failure. In other light duty applications carrying pharmaceutical products, however, many Aflex "Corroflon" hoses are still performing satisfactorily after 20 years in service).

(8) Service life predictions or guarantees can only be given in cases where all the relevant information concerning the application is given in writing to Aflex Hose, and Aflex Hose subsequently replies in writing prior to the order being placed.

(9) If such a written undertaking is not sought and given, then Aflex Hose cannot be held liable for any Aflex Hose Product failure which the Customer considers to be premature, excepting failures which are due to faulty materials or manufacturing defects which occur within 24 months of supply.

24 Month Warranty

(10) Aflex Hose Ltd warrants its Aflex Hose Products to be free from faulty materials or manufacturing defects from the date of the initial sale, for 24 months. An exception is that all Hose Assemblies which are "ETH" (Electrical Trace Heated) Grade are only warranted for 12 months.

Product Failure

(11) In the event of a product failure, Aflex Hose requires that the Aflex Hose Products should not be cut up or tampered with, but should be de-contaminated and returned to Aflex Hose, plus a decontamination certificate, for examination and analysis of the fault. The Customer should also provide full details in writing of the application conditions under which the hose failed, including Pressure, Vacuum, Temperature, Flexing and any cycling of any of these, also the fluid and gases passing through the hose, and the total time that the hose has been in service. The Customer may send his own witness to the examination if required. Aflex Hose will provide a full Non Conformance Report for the Customer.

(12) If faulty materials or a manufacturing defect in the hose was responsible for the hose failure, then the maximum liability which will be accepted by Aflex Hose will include the invoice value of the failed hose itself, or the invoice value of the whole customer order if appropriate, also any reasonable costs for removal and replacement of the hose, and costs for packing and despatching the failed hose back to Aflex Hose. Aflex Hose Ltd will not accept liability for any other consequential or financial losses, including, but not limited to loss of profits, loss of process products, damage to equipment, or downtime costs.

Untested Hose for Self Assembly by Customers

(13) Aflex Hose sometimes supplies "loose" hose, without end fittings attached to Self Assembly Customers, who will then cut the hose to length and attach end fittings to make up Hose Assemblies for their own use, or for sale to their own customers.

(14) Unless the Customer requests, and Aflex Hose confirm that the 'loose' hose is pressure tested before supply, such testing is not normally applied by Aflex Hose, because this testing requirement is otherwise satisfied by the Self Assembly Customer during his own testing of the finished Hose Assemblies made up using the "loose" hose.

Self Assembly Customers must then accept the responsibility to carry out hydrostatic pressure testing of 100% of such assemblies to 1½ times the Maximum Working Pressure (MWP) of the hose assembly as specified in the relevant Full Product Brochure before supply for end use, to validate both the hose and the end fitting attachment.

(15) When pressure testing hoses with a plastic or rubber outer cover, the cover will mask any signs of leakage for a time. It is therefore, required that after the hydrostatic pressure test, each covered hose assembly should also be tested with an internal helium gas pressure of 30 Bar (450 psi) for hose sizes up to 1" and 15 Bar (225 psi) for hose sizes above 1", with the hose assembly immersed in water to enable leak detection by gas bubbles, for a minimum test period of 5 minutes.

(16) The Self Assembly Customer must also accept responsibility for determining and approving the Design Suitability of the hose assemblies for their intended use before supply. This includes proceeding in accordance with (3) and (4) above.

(17) Aflex Hose will only accept liability for its Aflex Hose Products which are assembled by approved Self Assembly Customers if all the hose and fitting components were supplied by Aflex Hose or approved for use by Aflex Hose, and they were assembled and tested in accordance with Aflex Hose's current Manufacturing and Testing Instructions, available to approved Self Assemblers in an I-Bay on the Aflex Hose website.

Untested Hose Assemblies

(18) Aflex Hose is sometimes requested by Customers to attach non-standard end fittings to hose assemblies which they supply, and in some cases it is not possible to connect these fittings to the Aflex Hose pressure test system. In such cases a Concession not to test is obtained from the Customer, and a label is attached to the hose assembly, warning that it requires pressure testing before use.

Force Majeure

(19) Aflex Hose Ltd shall not be liable for any delay or default in performing in accordance with any Customers' order if the delay or default is caused by conditions beyond its control, including, but not limited to wars, insurrections, protests, strikes, natural disasters or performance failures by Carriers, sub-contractors or other third parties outside the control of Aflex Hose Ltd.

Legal System

(20) These Conditions of Sale are subject to English Law.



Aflex Hose Ltd

World's Leading Manufacturer of PTFE Flexible Hose

AFLEX HOSE LTD

Spring Bank Industrial Estate
Watson Mill Lane, Sowerby Bridge
Halifax, West Yorkshire HX6 3BW

T: 01422 317200 **F:** 01422 836000
W: www.aflex-hose.com



Aflex Hose USA, LLC

World's Leading Manufacturer of PTFE Flexible Hose

AFLEX HOSE USA, LLC

6111 Keller's Church Road, Unit B
Pipersville, Pennsylvania, PA18947

T: 215 766 1455 **F:** 215 766 1688
W: www.aflex-hose.com

